

ZAXIS-7 series

HITACHI

Reliable solutions

ZAXIS220W

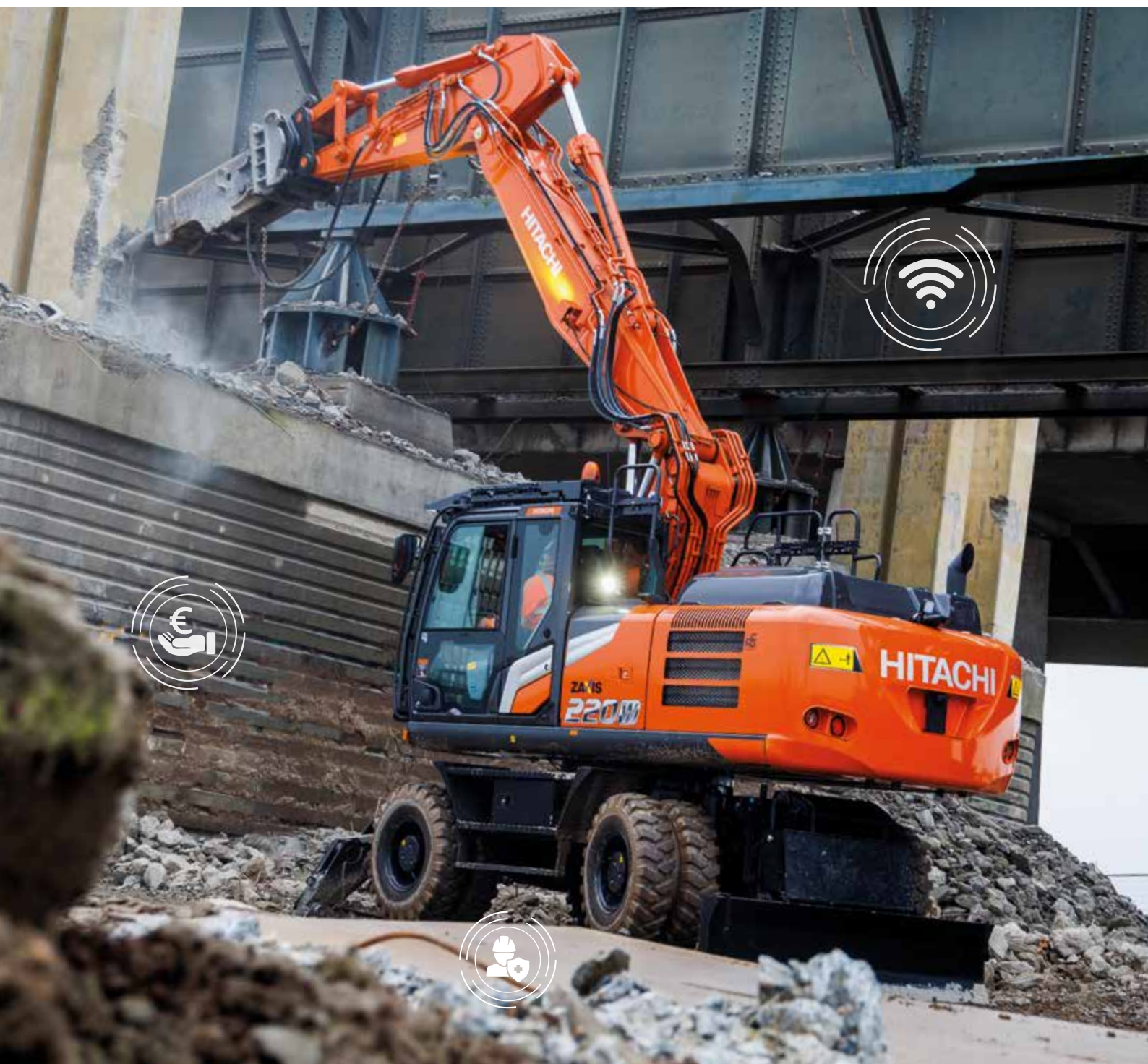

## HYDRAULIC EXCAVATOR

Model code : ZX220W-7

Engine rated power : 128 kW

Operating weight : 20 100 – 24 900 kg

Bucket ISO heaped : 0.51 – 1.20 m<sup>3</sup>



# You're in control

You're at the heart of Hitachi's design for its latest range of excavators. To continuously improve on previous generation machines we've focused on enhancing your experience in the cab as an operator.

We've considered the challenges you face as the owner of a successful business. And we've zoomed in on the ways in which we can support you over the life cycle of your machine.

By putting you at the heart of the Zaxis-7 range, we invite you to take control – over your workspace and your fleet. And by working in partnership, we will help you to create your vision.







# Inside



In control of your business

---

**8.** Improve your profit



In control of your comfort

---

**10.** Feel the difference



In control of your environment

---

**12.** Increase your safety



In control of your assets

---

**14.** Boost your uptime



In control of your fleet

---

**16.** Manage your machine



In control of your uptime

---

**18.** Protect your investment



In control of your performance

---

**20.** Get more from your machine



# Complete control

The new Zaxis-7 range of wheeled excavators puts you firmly in control, so you can feel assured of your machine's performance, and supported by the technological expertise and services that Hitachi provides.



The expanded cab interior provides a more comfortable working environment.



Sensors monitor oil continuously and contribute to preventative maintenance, helping to reduce downtime.



ConSite Pocket app allows you to manage and monitor your fleet remotely.



Options such as Hitachi ground engaging tools enable you to enhance the performance of your excavator.





Integrated console and seat suspension gives a greater sense of control, and helps to reduce fatigue.



Visibility of the job site is excellent thanks to the Aerial Angle camera system and new LCD monitor.

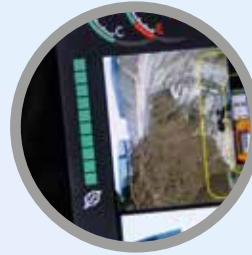

The ECO gauge on the monitor indicates how to lower fuel consumption and reduce costs.



Improved access to components ensures maintenance is quick and easy.



The HIOS III hydraulic system enhances productivity with reduced fuel consumption.





1

2

18

3

4

5

17

16

15

14

6

7

13

8

9

HITACHI

10

11

12



# Control zone

Enhanced comfort and safety features are at your fingertips in the refined cab of Zaxis-7 excavators, giving you the power to perform productively, with ease and reduced fatigue.

- 1 **Increased sweeping area of parallel link wiper** enhances visibility in difficult working conditions.
- 2 **Air conditioning and audio** are easily controlled via the monitor.
- 3 **Low-reflective colour 8" LCD monitor** is easy to view and navigate.
- 4 **USB socket and smartphone holder** helps you stay connected.
- 5 **Drinks holder** is easy to detach for cleaning.
- 6 **Additional joystick controls** for effortless operation.
- 7 **Ergonomic design** gives you convenient access to controls.
- 8 **Bluetooth®** for hands-free calls and **DAB+** radio for music while you work.
- 9 **Multifunctional control panel** makes operation easier.
- 10 **Improved sound isolation** makes this one of the quietest cabs in the market.
- 11 **User-friendly storage space** keeps your workspace tidy and clutter-free.
- 12 **Coat hooks** take care of your personal belongings.
- 13 **New blade and outrigger lever** provides fingertip control and is within easy reach.
- 14 **Integrated console and seat suspension** gives a greater sense of control and helps to reduce fatigue.
- 15 **One-touch adjustment lever for console** so you can work comfortably in the optimum position.
- 16 **Increased legroom** creates a more spacious cab.
- 17 **Front visibility** is improved by the slim steering column (with wider adjustment angle) and smaller steering wheel.
- 18 **Auto working brake** helps to reduce fatigue.



Operation is easy with ergonomically designed controls and switches.



Bluetooth® connection for hands-free calls while you work.



In control of your business



# Improve your profit

The success of your business depends on the reliability and efficiency of your construction machinery. With Hitachi's latest Zaxis-7 wheeled excavators, you can count on the highest quality, the ultimate in operating comfort and reduced running costs – all of which will have a positive impact on your bottom line.

You can look forward to increasing your profits thanks to the impressive fuel economy of these Stage-V compliant machines. The ZX220W-7 is equipped with the unique HIOS III hydraulic system, and achieves higher productivity with better fuel consumption than previous models, which helps to reduce costs.

The new Zaxis-7 wheeled excavators do not require the use of urea to comply with Stage V emission regulations, and this helps to reduce costs further.

Your operators can also control fuel efficiency – and reduce costs – by using the all-new ECO gauge. This is clearly visible on the multifunctional colour LCD eight-inch monitor.

In addition, you can boost your profits by working on a wider range of projects thanks to the excellent versatility of Zaxis-7 excavators. Different attachments are quickly changed using the enhanced attachment support system on the monitor.

With a simple adjustment to suit your operator's preference and job site requirements, you can fine-tune your machine for optimum productivity – while still reducing fuel consumption.



The HIOS III hydraulic system contributes to significant reductions in fuel consumption.





The HIOS III hydraulic system provides optimum operating efficiency on every job site.

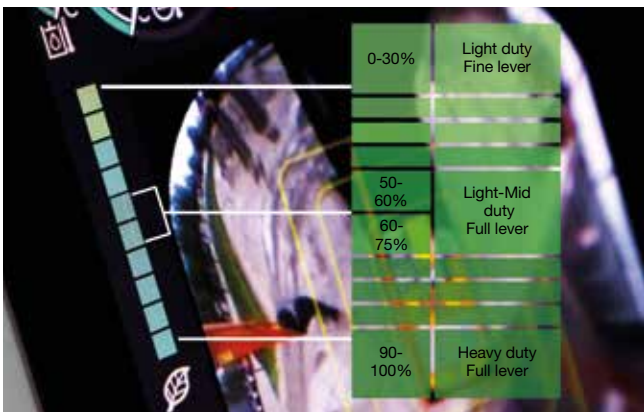

The ECO gauge helps to deliver better fuel consumption.



The attachment support system enables increased versatility.





You're in control with a spacious, tidy and enjoyable working environment.



The cab has ample space for your belongings.



The LCD monitor is easy to view with hi-res anti-glare screen.



In control of your comfort



# Feel the difference

Hitachi's redesigned, state-of-the-art Zaxis-7 excavator cab gives you the perfect working environment. The ultra-spacious ZX220W-7 offers you an industry-leading, first-class cab with the ultimate in comfort and quality, as well as low noise levels and less vibration than the previous generation.

Feel the difference with the synchronised motion of the seat and console, designed to ensure you feel less tired at the end of the working day. Stretch out in the most spacious Hitachi cab yet, with improved pedal layout, ample head clearance and legroom. And sit comfortably thanks to the easily adjustable console height with three positions to choose from.

Easy operation comes from the new ergonomic design of the console and switches, and convenient access to controls. You can navigate quickly through the menu on the 8" LCD monitor with the multifunctional controller. The hi-res anti-glare screen is also easier to view, and the refreshed layout offers a clear display and desirable functionality – such as air conditioning, DAB+ radio and Bluetooth.

With more storage for your personal belongings, such as your coat, smartphone and drink, you'll feel instantly relaxed and ready for your shift. Added practical functions to the joysticks, such as engine idle and audio mute controls, will make your working day effortless and enjoyable.



Ergonomic multifunctional control panel provides easy access.



In control of your environment



# Increase your safety

Your ability to work safely is vital, not only for your own wellbeing, but also for the successful completion of any project. To protect yourself and your machine from potential hazards, the new Hitachi Zaxis-7 excavators give you a superior view of your surroundings, so you can see the job site from all angles.

The visibility you enjoy from the cab includes an exceptional 270-degree bird's-eye view with the Aerial Angle camera system. You can choose from six image options to view the machine's immediate environment, which enables you to control your own safety – as well as that of those around you. Visibility through the cab's front window is also improved by the slim steering column (with wider adjustment angle) and smaller steering wheel.

To help you to work more confidently and efficiently, even in the most challenging of conditions, Zaxis-7 excavators are fitted with some impressive new features. From the LED work lights and the windscreen wiper with an increased sweeping area, wider mirrors (heated available as an option), to the large reflective strips on the counterweight and optional roller sunshades, you'll have the visibility you need when it matters most.

Attention to detail is also fundamental to a safe working environment – and the repositioning of the pilot shutoff lever is a perfect example. It is now within easy reach to prevent any unintentional actions. The parking brake also works with the pilot shutoff lever for added safety and convenience.



The lower first step makes entering the cab safer and easier.



Wider wiper design provides greater visibility.





Control your safety with the 270-degree view Aerial Angle camera system.



Choose between different image layouts to suit your working environment.



LED work lights improve visibility in challenging conditions.





The single-piece undercarriage frame is extremely robust.



Maintenance is easy at ground level.



Fenders on the undercarriage protect the upper structure and lights from dirt, keeping the machine clean.



Designed for durability and easy maintenance, Zaxis-7 excavators increase uptime and reduce the total cost of ownership.





In control of your assets



# Boost your uptime

Completing a project on time and on budget depends on the ability of your construction equipment to perform all day, every day. That's why Hitachi owners have profited from generations of ultra-reliable and durable machinery – and the Zaxis-7 range is no exception.

The latest Hitachi wheeled excavators have been built to last, so that you can remain in complete control of your assets. They have been tested rigorously and continuously at dedicated facilities in Japan with the goal of significantly boosting your uptime.

As a result, a wide range of durable new components have been fitted to the latest Stage-V compliant machines – even down to the detail of the rigidity of the door hinges. The reliable new single-piece undercarriage benefits from greater oscillation of the axles, enhanced outrigger hydraulics, reduced risk of oil leakages, and several other improvements. Now standard on our Zaxis-7 range is a high-performance hydraulic filter to capture any dust in the hydraulic oil and help to reduce running costs.

Downtime is prevented by the durable after-treatment system, and also minimised by the priority given to easy maintenance and cleaning – saving you time and money. Peace of mind comes from such features as the two-way disconnect switch. This makes it possible to shut down power without resetting data on the monitor and prevents the battery from discharging during welding.





# Manage your machine

Hitachi offers a wide range of after-sales services to help you feel in total control of your fleet and workload. These initiatives give you access to vital data and tools to manage your machine.

Remote monitoring systems Owner's Site and ConSite send operational data daily via GPRS or satellite from your excavator to [www.globaleservice.com](http://www.globaleservice.com). This includes: ratios of operating hours to enhance efficiency; fuel consumption to manage running costs; and machine location for planning purposes. ConSite summarises the information in a monthly email.

The ConSite Pocket App sends you real-time alerts for issues arising with your machine. You'll receive recommendations on what to do and step-by-step help guides. The app also enables you to see the location of your fleet.

A unique innovation continuously monitors the quality of engine and hydraulic oil, 24/7. Data is transmitted daily via two oil sensors to Global e-Service. These detect if the oil quality has deteriorated, due to contamination or low viscosity. If this happens, you and your authorised Hitachi dealer will receive an alert.

This innovative feature provides accurate estimations of when oil changes are required. It reduces maintenance and unscheduled downtime, and gives you peace of mind thanks to scheduled servicing and ultimately a higher resale value.



The unique oil sensor reduces maintenance and downtime.



A wide range of data on Global e-Service enhances efficiency.



The alerts on the ConSite Pocket App provide real-time information.





Hitachi offers a wide range of after-sales services for planning maintenance and managing running costs.





Hitachi provides the highest level of technical support.



Minimise downtime with Hitachi Genuine Parts.



HELP extended warranties and service contracts provide optimal performance.



Hitachi Premium Rental enables you to pay as you earn.





In control of your uptime



# Protect your investment

If your machine will be working in severe conditions, or you want to minimise repair costs, you can take advantage of a unique extended warranty programme called HELP (Hitachi Extended Life Program) and comprehensive service contracts. These can help to optimise performance, reduce downtime and ensure a higher resale value.

We apply the same technological expertise to our wide range of high-quality parts as we do our machines. As a result, you can minimise unscheduled downtime and ensure maximum availability.

The parts range includes Hitachi Genuine Parts, Performance Parts, filters, undercarriages, and remanufactured components. We also offer ground engaging tools and buckets, which have been manufactured to the same exacting standards.

As your business grows, you may need to extend your fleet to meet the demands of new contracts. Why not try before you buy with the Hitachi Premium Rental programme? This gives you immediate access to Zaxis-7 wheeled excavators for a period of one month to a year.

Along with the reliability, quality and service you would expect from the Hitachi brand, Hitachi Premium Rental offers flexible contracts and fixed costs that make it easier for you to budget.



In control of your performance



# GET more from your machine

Designed to work in perfect harmony with your machine, Hitachi's buckets and ground engaging tools (GET) will increase your profit by maximising productivity and uptime. Manufactured to the same high standards as all Hitachi construction equipment, they offer unrivalled reliability and exceptional performance.

## Buckets

You can increase the versatility of your excavator by choosing the right bucket for the job. For loading light materials or heavy-duty work, Hitachi buckets can be customised to meet your needs. You have a wide range of options to choose from – including digging buckets and ditch-cleaning buckets in GD and HD versions, with different capacities and widths – and quick coupler connections such as CW, pin grabber and S-coupling are also available.

## Ground engaging tools

You can enhance the digging power and productivity of your excavator with Hitachi GET. Quick and safe to install and replace, they fit precisely to your attachments and can be tailored to suit the task. Using Hitachi GET can reduce your maintenance costs and downtime, lower fuel consumption and enhance the overall performance of your machine.



Hitachi buckets and GET are manufactured to the same high standards as all Hitachi construction equipment.





Hitachi buckets can be customised to suit the application.



An optional trailer support package is available for added convenience and versatility.



Hitachi GET include self-sharpening teeth and reliable adapters to ensure a precise fit.





EH dump trucks and EX ultra-large excavators



Special application excavators





Create your vision

---

# In control of your world

When you take delivery of a Hitachi machine, you become part of the latest generation of a global family. With a 50-year heritage in designing hydraulic excavators, and a reputation as the industry's leading mining machine manufacturer, the Hitachi network will give you access to a range of exceptional construction equipment.

Like the new Zaxis-7 excavators, Hitachi wheel loaders, rigid dump trucks, and special application machines incorporate advanced technology and pioneering expertise. This is inspired by parent company Hitachi Ltd, which was founded on the philosophy to make a positive contribution to society through technology.

In addition to the latest products made at state-of-the-art facilities and built to the highest quality standards, you'll have the support of our experienced engineers and dedicated dealer personnel. You'll also benefit from market-leading services and initiatives, such as Premium Rental and Premium Used, which have been created to enhance your experience as a Hitachi customer.

Whatever vision you wish to create, Hitachi has the product, people, solutions and services you need to make it become a reality – and empower you to take control of your world.



ZW wheel loaders



Mini excavators



# SPECIFICATIONS

## ENGINE

Model .....	Isuzu 4HK1X
Type .....	4-cycle water-cooled, common rail direct injection
Aspiration .....	Variable geometry turbocharged, intercooled, cooled EGR
Aftertreatment .....	DOC+CSF+SCR system
No. of cylinders .....	4
Rated power	
ISO 14396 : 2002 gross ....	128.4 kW at 2 000 min <sup>-1</sup>
ISO 9249 : 2007 net .....	122 kW at 2 000 min <sup>-1</sup>
Maximum torque .....	670 Nm at 1 600 min <sup>-1</sup>
Piston displacement .....	5.193 L
Bore and stroke .....	115 mm x 125 mm
Batteries .....	2 x 12 V / 126 Ah

## HYDRAULIC SYSTEM

### Hydraulic Pumps

Main pumps .....	2 variable displacement axial piston pumps
Maximum oil flow .....	1 x 212 L/min
Maximum oil flow .....	1 x 218 L/min

Pilot pump .....	1 gear pump
Maximum oil flow .....	27.6 L/min

Steering pump .....	1 gear pump
Maximum oil flow .....	26.7 L/min

### Hydraulic Motors

Travel .....	1 variable displacement axial piston motor
Swing .....	1 axial piston motor

### Relief Valve Settings

Implement circuit .....	34.3 MPa
Swing circuit .....	30.2 MPa
Travel circuit .....	35.3 MPa
Pilot circuit .....	4.0 MPa
Power boost .....	38.3 MPa

### Hydraulic Cylinders

Unit: mm

	Quantity	Bore	Rod diameter
Boom (Monoblock boom)	2	125	85
Boom (2-piece boom)	2	130	85
Arm	1	135	95
Bucket	1	115	80
Positioning (2-Piece boom)	1	180	110

## UPPERSTRUCTURE

### Revolving Frame

D-section frame for resistance to deformation.

### Swing Device

Axial piston motor with planetary reduction gear is bathed in oil. Swing circle is singlerow. Swing parking brake is spring-set/hydraulic-released disc type.

Swing speed .....	11.9 min <sup>-1</sup>
Swing torque .....	59.1 kNm

## UNDERCARRIAGE

Wheeled type undercarriage. The frame is of welded, stress-relieved structure.

Drive system: 2 speed power shift transmission and variable displacement axial piston type travel motor.

Travel Speed (forward and reverse)

Max. travel speed .....	High : 27.5 km/h
	Low : 7.4 km/h
	Creep : 2.9 km/h

Maximum traction force ... 118 kN

Gradeability .....

60% (31 degree) continuous

Min. turning radius .....

7 200 mm

Axle:

All-wheel drive.  
The front axle can be locked hydraulically in any position.  
Oscillating Front Axle ... ± 6°

Brakes system:

Maintenance free wet-disc brakes on axle are standard.  
Fully hydraulic service brake system

## ENVIRONMENT

### Engine Emissions

EU Stage V

### Sounds Level

Sound level in cab according to ISO 6396 : 2008 ..... LpA 71 dB(A)

External sound level according to ISO 6395 : 2008 and

EU Directive 2000/14/EC ..... LwA 101 dB(A)

### Air Conditioning System

The air conditioning system contains fluorinated greenhouse gases.

Refrigerant type: HFC-134a, GWP: 1430, Amount: 0.85 kg, CO<sub>2</sub>e: 1.22 ton.

## SERVICE REFILL CAPACITIES

Unit: L

	ZX220W-7
Fuel tank	330.0
Engine coolant	28.0
Engine oil	23.0
Swing device	6.9
Transmission	2.5
Hydraulic system	310.0
Hydraulic oil tank	115.0
DEF/AdBlue® tank	34.5
Front differential gear (STD axle)	11.0
Rear differential gear (STD axle)	14.5
Hub reduction gear	
Front axle (STD axle)	2 x 2.5
Rear axle (STD axle)	2 x 2.5



## WEIGHTS

### Operating Weight

		ZX220W-7	
Arm length	Stabilization	Monoblock	2-Piece
		Standard gauge / Wide gauge	Standard gauge / Wide gauge
		kg	kg
2.41 m	Rear blade	–	20 800
	Rear outrigger	–	21 100
	Outrigger and blade	–	22 100
	Front and rear outrigger	–	22 400
2.61 m	Rear blade	–	20 800
	Rear outrigger	–	21 200
	Outrigger and blade	–	22 200
	Front and rear outrigger	–	22 500
2.91 m	Rear blade	–	20 900
	Rear outrigger	–	21 200
	Outrigger and blade	–	22 200
	Front and rear outrigger	–	22 500
2.42 m	Rear blade	20 100	–
	Rear outrigger	20 400	–
	Outrigger and blade	21 400	–
	Front and rear outrigger	21 800	–
2.91 m	Rear blade	20 200	–
	Rear outrigger	20 500	–
	Outrigger and blade	21 500	–
	Front and rear outrigger	21 900	–

Including 0.80 m<sup>3</sup> (ISO 7451 : 2007 heaped), bucket weight (660 kg) and counterweight (2 600 kg).  
Counterweight : Standard 2 600 kg, Optional 4 300 kg and 5 000 kg

## BUCKET AND ARM DIGGING FORCE

Unit: kN

		ZX220W-7			
Boom Type	Monoblock boom		2-Piece boom		
Arm length	2.42 m	2.91 m	2.41 m	2.61 m	2.91 m
Bucket digging force* ISO 6015 : 2006	158	158	158	158	158
Arm crowd force* ISO 6015 : 2006	140	114	125	119	114

\* At power boost



# SPECIFICATIONS

ZX220W-7

## WORKING RANGES: MONOBLOCK BOOM

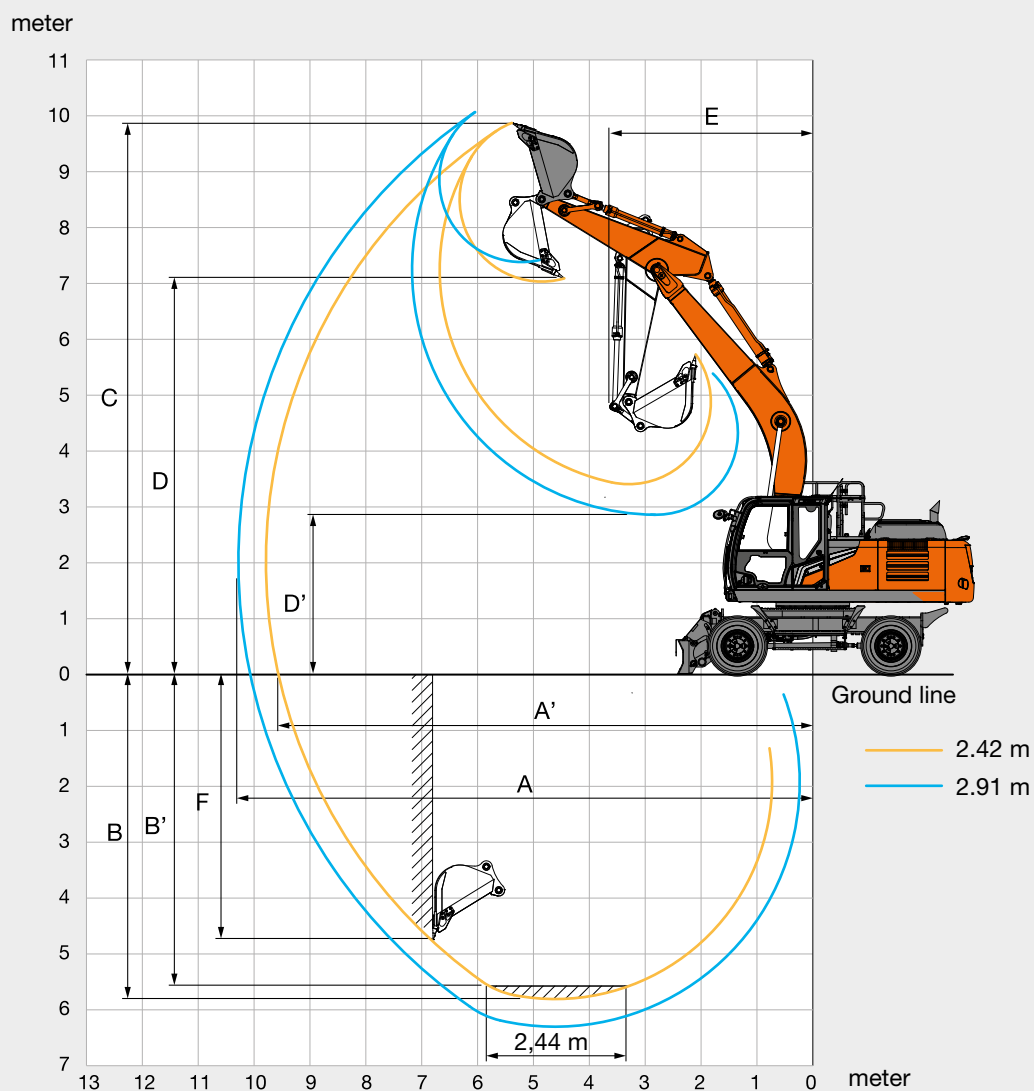

Unit: mm

	ZX220W-7	
	Monoblock boom	
Front type		
Arm length	2.42 m	2.91 m
A Max. digging reach	9 790	10 280
A' Max. digging reach (on ground)	9 570	10 070
B Max. digging depth	5 810	6 300
B' Max. digging depth for 2.44 m level	5 590	6 120
C Max. cutting height	9 880	10 250
D Max. dumping height	7 040	7 390
D' Min. dumping height	3 410	2 860
E Min. swing radius	3 640	3 550
F Max. vertical wall digging depth	5 080	5 770

# SPECIFICATIONS

ZX220W-7

## WORKING RANGES: 2-PIECE BOOM

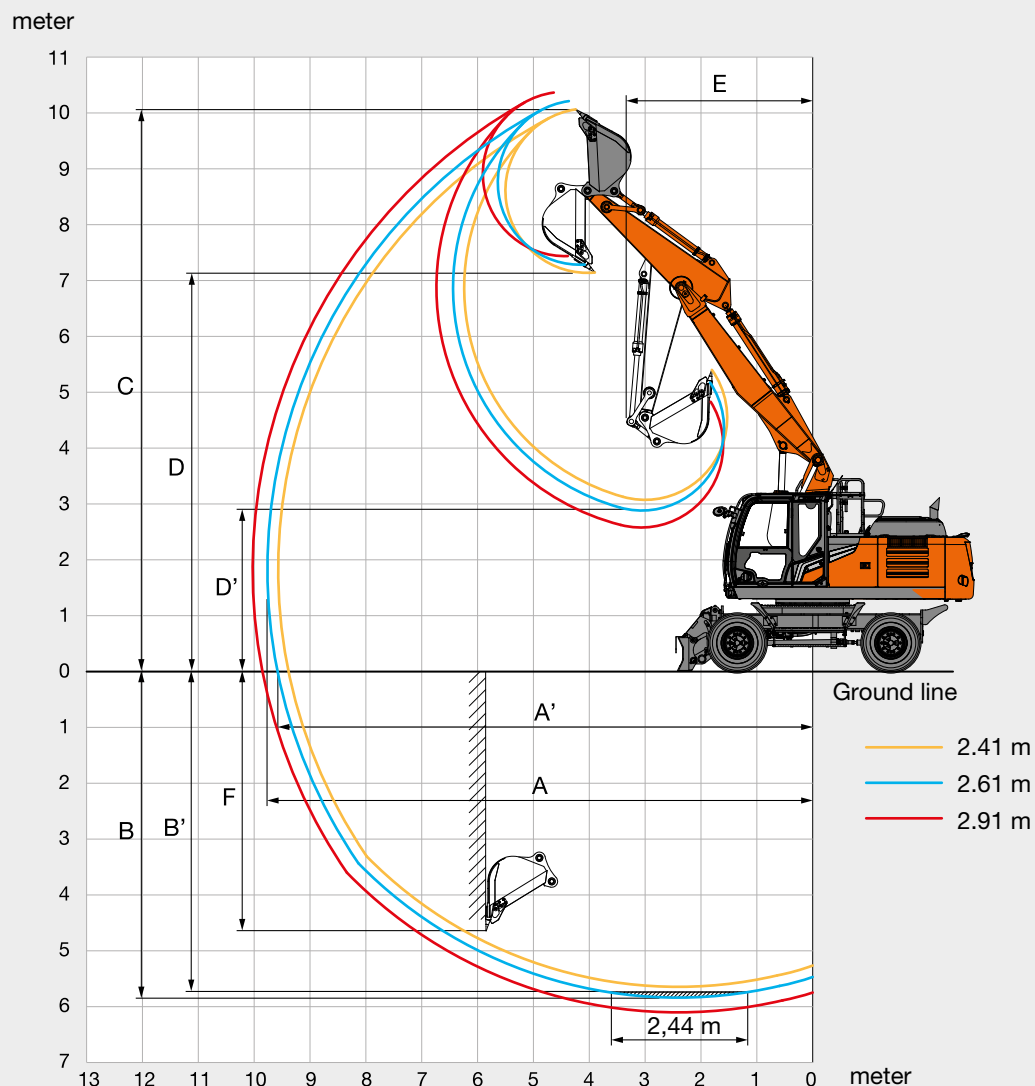

Unit: mm

Front type	ZX220W-7		
	2-Piece boom		
Arm length	2.41m	2.61 m	2.91 m
A Max. digging reach	9 570	9 760	10 030
A' Max. digging reach (on ground)	9 380	9 580	9 850
B Max. digging depth	5 650	5 840	6 140
B' Max. digging depth for 2.44 m level	5 550	5 750	6 050
C Max. cutting height	10 070	10 210	10 370
D Max. dumping height	7 140	7 280	7 440
D' Min. dumping height	3 070	2 880	2 580
E Min. swing radius	3 330	3 400	3 420
F Max. vertical wall digging depth	4 820	5 030	5 340



# SPECIFICATIONS

ZX220W-7

## DIMENSIONS

### MONOBLOCK BOOM

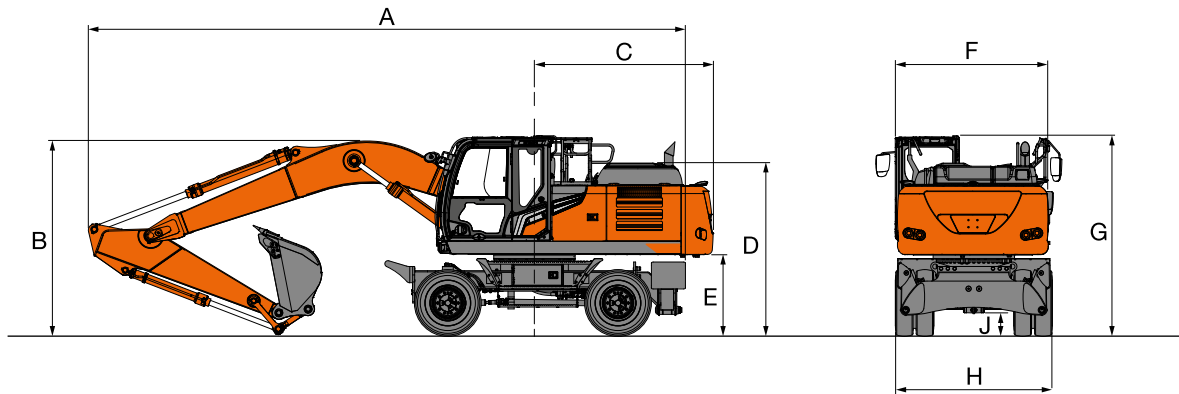

### 2-PIECE BOOM

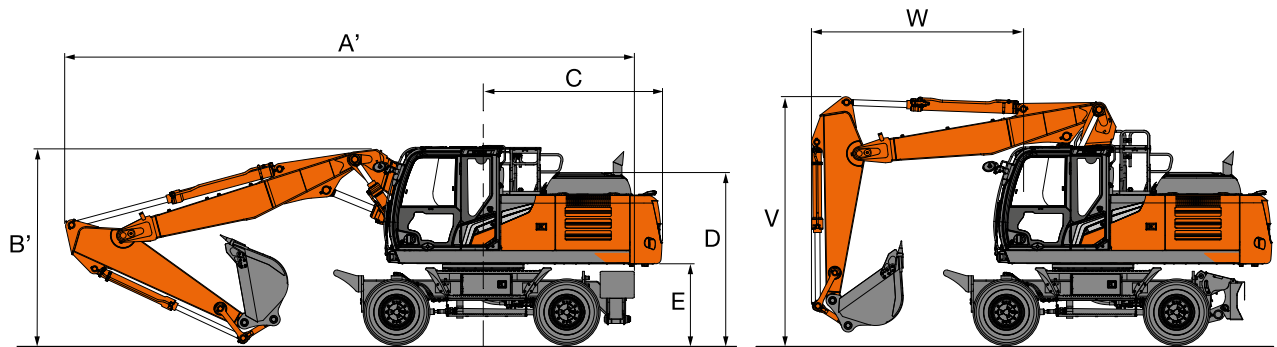

### FRONT BLADE AND REAR OUTRIGGER

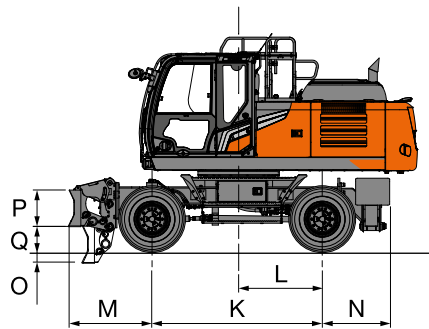

### FRONT AND REAR OUTRIGGER

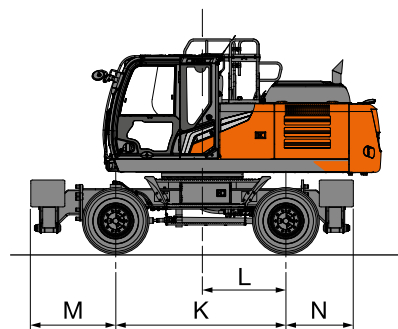

### REAR BLADE

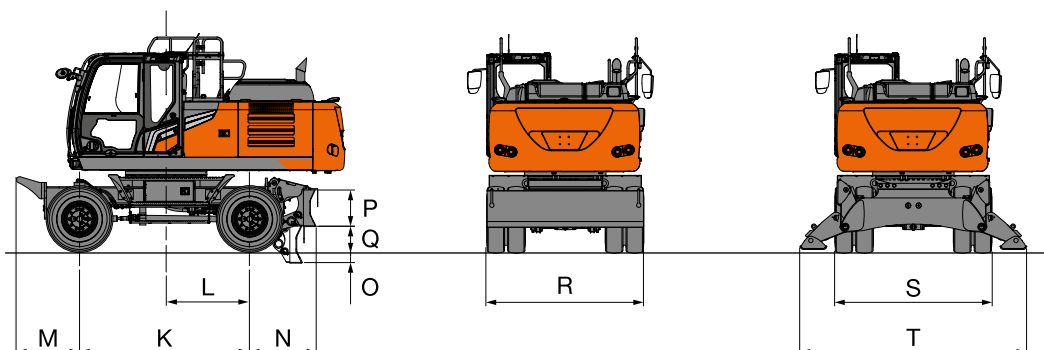

# SPECIFICATIONS

## ZX220W-7

### DIMENSIONS

Unit: mm

		ZX220W-7				
	Stabilizer Type	Rear BL	Rear O/R	Front BL Rear O/R	Front O/R Rear BL	Front and Rear O/R
A	Overall length (with monoblock boom)					
	Arm 2.42 m	10 100	10 100	10 100	10 100	10 100
	Arm 2.91 m	10 100	10 100	10 100	10 100	10 100
A'	Overall length (with 2-piece boom)					
	Arm 2.41 m	9 645	9 645	9 645	9 645	9 645
	Arm 2.61 m	9 645	9 645	9 645	9 645	9 645
	Arm 2.91 m	9 645	9 645	9 645	9 645	9 645
B	Overall height of boom (with monoblock boom)					
	Arm 2.42 m	3 265	3 265	3 265	3 265	3 265
	Arm 2.91 m	3 225	3 225	3 225	3 225	3 225
B'	Overall height of boom (with 2-piece boom)					
	Arm 2.41 m	3 220	3 220	3 220	3 220	3 220
	Arm 2.61 m	3 270	3 270	3 270	3 270	3 270
	Arm 2.91 m	3 330	3 330	3 330	3 330	3 330
C	Rear-end swing radius	2 890	2 890	2 890	2 890	2 890
D	Engine cover height	2 770	2 770	2 770	2 770	2 770
E	Counterweight clearance	1 250	1 250	1 250	1 250	1 250
F	Overall width of upper structure	2 500	2 500	2 500	2 500	2 500
G	Overall height of cabin	3 215	3 215	3 215	3 215	3 215
H	Overall width of tires	2 540 / 2 740 *	2 540 / 2 740 *	2 540 / 2 740 *	2 540 / 2 740 *	2 540 / 2 740 *
J	Min.ground clearance	305	305	305	305	305
K	Wheel base	2 750	2 750	2 750	2 750	2 750
L	Swing-center to rear axle	1 350	1 350	1 350	1 350	1 350
M	Front overhang	1 020	1 020	1 355	1 375	1 375
N	Rear overhang	1 075	1 090	1 090	1 075	1 090
O	Max. blade lower	210	-	210	210	-
P	Blade height	600	-	600	600	-
Q	Max. blade raise	380	-	380	380	-
R	Overall blade width	2 530 / 2 730	-	2 530 / 2 730	2 530 / 2 730	-
S	Overall Width O/R Retract	-	2 470 / 2 730	2 470 / 2 730	2 470 / 2 730	2 470 / 2 730
T	Overall Width O/R Extend	-	3 650 / 3 910	3 650 / 3 910	3 650 / 3 910	3 650 / 3 910
V	Overall boom height (traveling) (for 2-Piece boom only)					
	Arm 2.41 m	3 995	3 995	3 995	3 995	3 995
	Arm 2.61 m	3 985	3 985	3 985	3 985	3 985
	Arm 2.91 m	3 985	3 985	3 985	3 985	3 985
W	Front overhang (traveling) (for 2-Piece boom only)					
	Arm 2.41 m	3 500	3 500	3 500	3 500	3 500
	Arm 2.61 m	3 500	3 500	3 500	3 500	3 500
	Arm 2.91 m	3 500	3 500	3 500	3 500	3 500

Overall machine width is the largest value of either F, H, R or S.

Transportation dimensions are A (A'), B (B'), and the largest value of either F, H, R or S.

\* Equipped with wide gauge and Caliber twin tires 315 / 70R 22.5 : Dimensions H = 2 770 mm



# MACHINE CAPACITIES

## ZX220W-7

- Notes:
1. Ratings are based on ISO 10567 : 2007.
  2. Machine capacity does not exceed 75% of tipping load with the machine on firm, level ground or 87% full hydraulic capacity.
  3. The load point is the center-line of the bucket pivot mounting pin on the arm.
  4. \*Indicates load limited by hydraulic capacity.
  5. Each value with Rear blade up over the Front-axle side and each value with Rear blade down over the Rear-axle side respectively, and value in optimal position with positioning cylinder.
  6. 0 m = Ground.

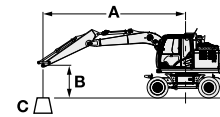

- A: Load radius  
B: Load point height  
C: Machine capacity

For machine capacities, subtract installed attachment and quick hitch weight from machine capacities.

To determine lifting capacities, apply "Rating over-side or 360 degrees" machine capacities from the table and deduct weight of installed attachment and quick hitch.

Optional feature may affect machine performance.











### ZX220W-7 MONOBLOCK BOOM, ARM 2.42 M, 2 600 KG COUNTERWEIGHT, STANDARD GAUGE

Rating over-front or rear Rating over-side or 360 degrees Unit : kg

Load point height (m)	Stabilization	Load radius								At max. reach		meter
		3.0 m		4.5 m		6.0 m		7.5 m				
6.0 m	Rear blade up (over front)					5 070	3 130			3 690	2 230	7.23
	Rear blade down (over rear)					*6 380	3 540			*6 040	2 540	
	Rear outrigger down (over rear)					*6 380	4 200			6 030	3 040	
	Front outrigger and rear blade down (over rear)					*6 380	5 380			*6 040	3 920	
	Front blade and rear outrigger down (over rear)					*6 380	5 500			*6 040	4 010	
	4 outrigger down (over rear)					*6 380	*6 380			*6 040	4 670	
4.5 m	Rear blade up (over front)			7 630	4 550	4 860	2 940	3 410	2 030	3 110	1 830	7.91
	Rear blade down (over rear)			*8 810	5 180	*7 150	3 350	*6 430	2 320	5 940	2 100	
	Rear outrigger down (over rear)			*8 810	6 230	*7 150	4 000	5 580	2 790	5 090	2 540	
	Front outrigger and rear blade down (over rear)			*8 810	8 130	*7 150	5 170	*6 430	3 620	*6 020	3 310	
	Front blade and rear outrigger down (over rear)			*8 810	8 330	*7 150	5 290	6 220	3 710	5 670	3 390	
	4 outrigger down (over rear)			*8 810	*8 810	*7 150	6 180	*6 430	4 330	5 880	3 960	
3.0 m	Rear blade up (over front)			6 940	3 950	4 590	2 690	3 290	1 920	2 830	1 630	8.26
	Rear blade down (over rear)			*11 400	4 560	*8 240	3 090	6 390	2 210	5 440	1 880	
	Rear outrigger down (over rear)			*11 400	5 570	7 840	3 730	5 450	2 680	4 660	2 290	
	Front outrigger and rear blade down (over rear)			*11 400	7 430	*8 240	4 880	*6 870	3 510	6 260	3 020	
	Front blade and rear outrigger down (over rear)			*11 400	7 630	*8 240	5 000	6 080	3 590	5 210	3 090	
	4 outrigger down (over rear)			*11 400	9 130	*8 240	5 890	6 300	4 210	5 400	3 620	
1.5 m	Rear blade up (over front)			6 480	3 540	4 340	2 470	3 170	1 810	2 740	1 550	8.3
	Rear blade down (over rear)			*11 770	4 140	9 020	2 860	6 240	2 090	5 320	1 800	
	Rear outrigger down (over rear)			*11 770	5 130	7 550	3 500	5 310	2 560	4 540	2 210	
	Front outrigger and rear blade down (over rear)			*11 770	6 960	*9 190	4 640	7 180	3 390	6 120	2 920	
	Front blade and rear outrigger down (over rear)			*11 770	7 150	8 430	4 750	5 950	3 470	5 090	2 990	
	4 outrigger down (over rear)			*11 770	8 630	8 730	5 630	6 160	4 080	5 280	3 520	
0 m (Ground)	Rear blade up (over front)			6 330	3 420	4 200	2 340	3 100	1 740	2 810	1 580	8.05
	Rear blade down (over rear)			*13 410	4 010	8 840	2 730	6 150	2 020	5 520	1 840	
	Rear outrigger down (over rear)			12 260	5 000	7 380	3 360	5 230	2 490	4 710	2 260	
	Front outrigger and rear blade down (over rear)			*13 410	6 810	*9 640	4 500	7 090	3 310	6 360	3 010	
	Front blade and rear outrigger down (over rear)			*13 410	7 000	8 260	4 610	5 860	3 390	5 280	3 080	
	4 outrigger down (over rear)			*13 410	8 470	8 570	5 480	6 080	4 000	5 480	3 630	
-1.5 m	Rear blade up (over front)	*9 190	6 460	6 350	3 430	4 170	2 310			3 110	1 750	7.48
	Rear blade down (over rear)	*9 190	7 690	*12 760	4 020	8 800	2 700			6 190	2 040	
	Rear outrigger down (over rear)	*9 190	*9 190	12 280	5 010	7 350	3 330			5 250	2 500	
	Front outrigger and rear blade down (over rear)	*9 190	*9 190	*12 760	6 830	*9 430	4 470			7 130	3 330	
	Front blade and rear outrigger down (over rear)	*9 190	*9 190	*12 760	7 020	8 230	4 580			5 890	3 410	
	4 outrigger down (over rear)	*9 190	*9 190	*12 760	8 490	8 530	5 450			6 110	4 020	
-3.0 m	Rear blade up (over front)	13 180	6 630	6 490	3 550	4 270	2 400			3 860	2 190	6.49
	Rear blade down (over rear)	*15 190	7 880	*11 150	4 150	*8 220	2 790			*7 300	2 540	
	Rear outrigger down (over rear)	*15 190	10 040	*11 150	5 140	7 460	3 420			6 620	3 110	
	Front outrigger and rear blade down (over rear)	*15 190	14 340	*11 150	6 960	*8 220	4 560			*7 300	4 120	
	Front blade and rear outrigger down (over rear)	*15 190	14 850	*11 150	7 160	*8 220	4 680			*7 300	4 220	
	4 outrigger down (over rear)	*15 190	*15 190	*11 150	8 630	*8 220	5 550			*7 300	4 990	

**ZX220W-7 MONOBLOCK BOOM, ARM 2.42 M, 2 600 KG COUNTERWEIGHT, WIDE GAUGE**

 Rating over-front or rear  Rating over-side or 360 degrees Unit : kg

Load point height (m)	Stabilization	Load radius								At max. reach		
		3.0 m		4.5 m		6.0 m		7.5 m				meter
												
6.0 m	Rear blade up (over front)					5 100	3 510			3 720	2 520	7.23
	Rear blade down (over rear)					*6 380	3 930			*6 040	2 840	
	Rear outrigger down (over rear)					*6 380	4 680			*6 040	3 400	
	Front outrigger and rear blade down (over rear)					*6 380	5 960			*6 040	4 350	
	Front blade and rear outrigger down (over rear)					*6 380	6 090			*6 040	4 440	
	4 outrigger down (over rear)					*6 380	*6 380			*6 040	5 200	
4.5 m	Rear blade up (over front)			7 670	5 130	4 890	3 310	3 430	2 300	3 130	2 080	7.91
	Rear blade down (over rear)			*8 810	5 810	*7 150	3 740	*6 430	2 600	5 960	2 360	
	Rear outrigger down (over rear)			*8 810	7 000	*7 150	4 470	5 600	3 130	5 110	2 850	
	Front outrigger and rear blade down (over rear)			*8 810	*8 810	*7 150	5 740	*6 430	4 020	*6 020	3 680	
	Front blade and rear outrigger down (over rear)			*8 810	*8 810	*7 150	5 870	6 250	4 110	5 710	3 760	
	4 outrigger down (over rear)			*8 810	*8 810	*7 150	6 910	*6 430	4 820	5 930	4 410	
3.0 m	Rear blade up (over front)			6 980	4 510	4 610	3 050	3 310	2 180	2 850	1 860	8.26
	Rear blade down (over rear)			*11 400	5 160	*8 240	3 470	6 410	2 490	5 460	2 130	
	Rear outrigger down (over rear)			*11 400	6 330	7 870	4 200	5 470	3 010	4 680	2 580	
	Front outrigger and rear blade down (over rear)			*11 400	8 390	*8 240	5 450	*6 870	3 900	*6 280	3 360	
	Front blade and rear outrigger down (over rear)			*11 400	8 610	*8 240	5 580	6 120	3 990	5 240	3 440	
	4 outrigger down (over rear)			*11 400	10 400	*8 240	6 610	6 350	4 700	5 450	4 050	
1.5 m	Rear blade up (over front)			6 520	4 090	4 370	2 830	3 190	2 070	2 760	1 780	8.3
	Rear blade down (over rear)			*11 770	4 730	9 050	3 240	6 260	2 370	5 330	2 040	
	Rear outrigger down (over rear)			*11 770	5 870	7 580	3 960	5 330	2 890	4 560	2 490	
	Front outrigger and rear blade down (over rear)			*11 770	7 900	*9 190	5 200	7 240	3 780	6 180	3 260	
	Front blade and rear outrigger down (over rear)			*11 770	8 120	8 480	5 330	5 980	3 870	5 120	3 340	
	4 outrigger down (over rear)			*11 770	9 870	8 810	6 340	6 220	4 570	5 330	3 940	
0 m (Ground)	Rear blade up (over front)			6 380	3 960	4 230	2 690	3 120	2 000	2 830	1 820	8.05
	Rear blade down (over rear)			*13 410	4 600	8 870	3 100	6 170	2 300	5 540	2 090	
	Rear outrigger down (over rear)			12 300	5 730	7 410	3 820	5 240	2 820	4 720	2 560	
	Front outrigger and rear blade down (over rear)			*13 410	7 740	*9 640	5 050	7 150	3 700	6 420	3 360	
	Front blade and rear outrigger down (over rear)			*13 410	7 960	8 310	5 180	5 890	3 790	5 310	3 440	
	4 outrigger down (over rear)			*13 410	9 710	8 640	6 190	6 130	4 490	5 520	4 070	
-1.5 m	Rear blade up (over front)	*9 190	7 580	6 390	3 970	4 200	2 670			3 140	2 010	7.48
	Rear blade down (over rear)	*9 190	8 970	*12 760	4 610	8 830	3 080			6 210	2 310	
	Rear outrigger down (over rear)	*9 190	*9 190	12 320	5 740	7 370	3 790			5 270	2 840	
	Front outrigger and rear blade down (over rear)	*9 190	*9 190	*12 760	7 760	*9 430	5 020			*7 150	3 720	
	Front blade and rear outrigger down (over rear)	*9 190	*9 190	*12 760	7 980	8 280	5 150			5 930	3 810	
	4 outrigger down (over rear)	*9 190	*9 190	*12 760	9 730	8 600	6 160			6 160	4 520	
-3.0 m	Rear blade up (over front)	13 260	7 760	6 530	4 100	4 290	2 760			3 880	2 510	6.49
	Rear blade down (over rear)	*15 190	9 160	*11 150	4 740	*8 220	3 170			*7 300	2 880	
	Rear outrigger down (over rear)	*15 190	11 770	*11 150	5 880	7 490	3 880			6 640	3 520	
	Front outrigger and rear blade down (over rear)	*15 190	*15 190	*11 150	7 900	*8 220	5 120			*7 300	4 610	
	Front blade and rear outrigger down (over rear)	*15 190	*15 190	*11 150	8 120	*8 220	5 250			*7 300	4 730	
	4 outrigger down (over rear)	*15 190	*15 190	*11 150	9 880	*8 220	6 260			*7 300	5 610	



# MACHINE CAPACITIES

## ZX220W-7

- Notes:
1. Ratings are based on ISO 10567 : 2007.
  2. Machine capacity does not exceed 75% of tipping load with the machine on firm, level ground or 87% full hydraulic capacity.
  3. The load point is the center-line of the bucket pivot mounting pin on the arm.
  4. \*Indicates load limited by hydraulic capacity.
  5. Each value with Rear blade up over the Front-axle side and each value with Rear blade down over the Rear-axle side respectively, and value in optimal position with positioning cylinder.
  6. 0 m = Ground.

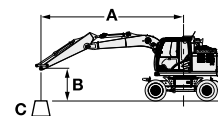

- A: Load radius  
B: Load point height  
C: Machine capacity

For machine capacities, subtract installed attachment and quick hitch weight from machine capacities.

To determine lifting capacities, apply "Rating over-side or 360 degrees" machine capacities from the table and deduct weight of installed attachment and quick hitch.

Optional feature may affect machine performance.











### ZX220W-7 MONOBLOCK BOOM, ARM 2.42 M, 4 300 KG COUNTERWEIGHT, STANDARD GAUGE

Rating over-front or rear Rating over-side or 360 degrees Unit : kg

Load point height (m)	Stabilization	Load radius								At max. reach		meter
		3.0 m		4.5 m		6.0 m		7.5 m				
6.0 m	Rear blade up (over front)					6 170	4 020			4 560	2 950	7.23
	Rear blade down (over rear)					*6 380	4 480			*6 040	3 290	
	Rear outrigger down (over rear)					*6 380	5 210			*6 040	3 850	
	Front outrigger and rear blade down (over rear)					*6 380	*6 380			*6 040	4 810	
	Front blade and rear outrigger down (over rear)					*6 380	*6 380			*6 040	4 910	
	4 outrigger down (over rear)					*6 380	*6 380			*6 040	5 630	
4.5 m	Rear blade up (over front)			*8 810	5 820	5 960	3 840	4 240	2 710	3 890	2 480	7.91
	Rear blade down (over rear)			*8 810	6 540	*7 150	4 290	*6 430	3 040	*6 020	2 780	
	Rear outrigger down (over rear)			*8 810	7 710	*7 150	5 020	*6 430	3 560	*6 020	3 260	
	Front outrigger and rear blade down (over rear)			*8 810	*8 810	*7 150	6 290	*6 430	4 470	*6 020	4 100	
	Front blade and rear outrigger down (over rear)			*8 810	*8 810	*7 150	6 430	*6 430	4 560	*6 020	4 190	
	4 outrigger down (over rear)			*8 810	*8 810	*7 150	*7 150	*6 430	5 250	*6 020	4 810	
3.0 m	Rear blade up (over front)			8 580	5 220	5 690	3 580	4 120	2 600	3 570	2 240	8.26
	Rear blade down (over rear)			*11 400	5 910	*8 240	4 030	*6 870	2 930	*6 280	2 530	
	Rear outrigger down (over rear)			*11 400	7 050	*8 240	4 750	6 580	3 450	5 650	2 980	
	Front outrigger and rear blade down (over rear)			*11 400	9 110	*8 240	6 010	*6 870	4 350	*6 280	3 770	
	Front blade and rear outrigger down (over rear)			*11 400	9 330	*8 240	6 140	*6 870	4 440	6 200	3 850	
	4 outrigger down (over rear)			*11 400	11 010	*8 240	7 120	*6 870	5 120	*6 280	4 430	
1.5 m	Rear blade up (over front)			8 110	4 810	5 440	3 360	4 000	2 490	3 470	2 160	8.3
	Rear blade down (over rear)			*11 770	5 490	*9 190	3 800	*7 320	2 820	6 390	2 440	
	Rear outrigger down (over rear)			*11 770	6 610	9 130	4 510	6 440	3 330	5 530	2 890	
	Front outrigger and rear blade down (over rear)			*11 770	8 640	*9 190	5 760	*7 320	4 230	*6 690	3 670	
	Front blade and rear outrigger down (over rear)			*11 770	8 860	*9 190	5 890	7 080	4 320	6 080	3 750	
	4 outrigger down (over rear)			*11 770	10 510	*9 190	6 860	7 290	5 000	6 270	4 330	
0 m (Ground)	Rear blade up (over front)			7 970	4 680	5 300	3 230	3 930	2 420	3 580	2 210	8.05
	Rear blade down (over rear)			*13 410	5 360	*9 640	3 670	7 400	2 740	6 640	2 500	
	Rear outrigger down (over rear)			*13 410	6 480	8 960	4 370	6 360	3 260	5 730	2 970	
	Front outrigger and rear blade down (over rear)			*13 410	8 490	*9 640	5 620	*7 520	4 160	*6 920	3 780	
	Front blade and rear outrigger down (over rear)			*13 410	8 710	*9 640	5 750	6 990	4 250	6 310	3 870	
	4 outrigger down (over rear)			*13 410	10 350	*9 640	6 710	7 210	4 920	6 500	4 470	
-1.5 m	Rear blade up (over front)	*9 190	8 660	7 980	4 700	5 270	3 200			3 950	2 440	7.48
	Rear blade down (over rear)	*9 190	*9 190	*12 760	5 380	*9 430	3 640			*7 150	2 760	
	Rear outrigger down (over rear)	*9 190	*9 190	*12 760	6 490	8 920	4 350			6 390	3 280	
	Front outrigger and rear blade down (over rear)	*9 190	*9 190	*12 760	8 510	*9 430	5 590			*7 150	4 180	
	Front blade and rear outrigger down (over rear)	*9 190	*9 190	*12 760	8 730	*9 430	5 720			7 030	4 270	
	4 outrigger down (over rear)	*9 190	*9 190	*12 760	10 370	*9 430	6 680			*7 150	4 950	
-3.0 m	Rear blade up (over front)	*15 190	8 840	8 120	4 820	5 370	3 290			4 850	3 000	6.49
	Rear blade down (over rear)	*15 190	10 280	*11 150	5 500	*8 220	3 730			*7 300	3 390	
	Rear outrigger down (over rear)	*15 190	12 770	*11 150	6 620	*8 220	4 440			*7 300	4 030	
	Front outrigger and rear blade down (over rear)	*15 190	*15 190	*11 150	8 650	*8 220	5 690			*7 300	5 140	
	Front blade and rear outrigger down (over rear)	*15 190	*15 190	*11 150	8 860	*8 220	5 820			*7 300	5 250	
	4 outrigger down (over rear)	*15 190	*15 190	*11 150	10 510	*8 220	6 780			*7 300	6 100	

**ZX220W-7 MONOBLOCK BOOM, ARM 2.42 M, 4 300 KG COUNTERWEIGHT, WIDE GAUGE**

 Rating over-front or rear  Rating over-side or 360 degrees Unit : kg

Load point height (m)	Stabilization	Load radius								At max. reach		
		3.0 m		4.5 m		6.0 m		7.5 m				meter
												
6.0 m	Rear blade up (over front)					6 200	4 440			4 590	3 260	7.23
	Rear blade down (over rear)					*6 380	4 920			*6 040	3 630	
	Rear outrigger down (over rear)					*6 380	5 750			*6 040	4 240	
	Front outrigger and rear blade down (over rear)					*6 380	*6 380			*6 040	5 280	
	Front blade and rear outrigger down (over rear)					*6 380	*6 380			*6 040	5 390	
	4 outrigger down (over rear)					*6 380	*6 380			*6 040	*6 040	
4.5 m	Rear blade up (over front)			*8 810	6 470	5 990	4 250	4 260	3 010	3 910	2 750	7.91
	Rear blade down (over rear)			*8 810	7 240	*7 150	4 720	*6 430	3 360	*6 020	3 070	
	Rear outrigger down (over rear)			*8 810	8 580	*7 150	5 540	*6 430	3 940	*6 020	3 610	
	Front outrigger and rear blade down (over rear)			*8 810	*8 810	*7 150	6 930	*6 430	4 910	*6 020	4 510	
	Front blade and rear outrigger down (over rear)			*8 810	*8 810	*7 150	7 080	*6 430	5 010	*6 020	4 600	
	4 outrigger down (over rear)			*8 810	*8 810	*7 150	*7 150	*6 430	5 790	*6 020	5 310	
3.0 m	Rear blade up (over front)			8 620	5 850	5 710	3 990	4 140	2 900	3 590	2 500	8.26
	Rear blade down (over rear)			*11 400	6 600	*8 240	4 460	*6 870	3 240	*6 280	2 800	
	Rear outrigger down (over rear)			*11 400	7 900	*8 240	5 270	6 600	3 820	5 670	3 300	
	Front outrigger and rear blade down (over rear)			*11 400	10 180	*8 240	6 640	*6 870	4 790	*6 280	4 150	
	Front blade and rear outrigger down (over rear)			*11 400	10 440	*8 240	6 790	*6 870	4 890	6 240	4 230	
	4 outrigger down (over rear)			*11 400	*11 400	*8 240	7 920	*6 870	5 670	*6 280	4 900	
1.5 m	Rear blade up (over front)			8 150	5 430	5 470	3 760	4 020	2 790	3 490	2 420	8.3
	Rear blade down (over rear)			*11 770	6 170	*9 190	4 230	*7 320	3 130	6 410	2 710	
	Rear outrigger down (over rear)			*11 770	7 450	9 150	5 030	6 460	3 700	5 540	3 210	
	Front outrigger and rear blade down (over rear)			*11 770	9 690	*9 190	6 390	*7 320	4 670	*6 690	4 050	
	Front blade and rear outrigger down (over rear)			*11 770	9 940	*9 190	6 530	7 110	4 770	6 110	4 130	
	4 outrigger down (over rear)			*11 770	*11 770	*9 190	7 650	*7 320	5 540	6 310	4 790	
0 m (Ground)	Rear blade up (over front)			8 010	5 300	5 330	3 630	3 950	2 720	3 590	2 480	8.05
	Rear blade down (over rear)			*13 410	6 030	*9 640	4 090	7 420	3 050	6 660	2 780	
	Rear outrigger down (over rear)			*13 410	7 300	8 980	4 890	6 380	3 630	5 750	3 300	
	Front outrigger and rear blade down (over rear)			*13 410	9 540	*9 640	6 240	*7 520	4 590	*6 920	4 170	
	Front blade and rear outrigger down (over rear)			*13 410	9 790	*9 640	6 390	7 030	4 690	6 340	4 260	
	4 outrigger down (over rear)			*13 410	11 740	*9 640	7 500	7 260	5 460	6 550	4 950	
-1.5 m	Rear blade up (over front)	*9 190	*9 190	8 030	5 320	5 300	3 600			3 970	2 730	7.48
	Rear blade down (over rear)	*9 190	*9 190	*12 760	6 050	*9 430	4 070			*7 150	3 070	
	Rear outrigger down (over rear)	*9 190	*9 190	*12 760	7 320	8 950	4 860			6 410	3 650	
	Front outrigger and rear blade down (over rear)	*9 190	*9 190	*12 760	9 560	*9 430	6 210			*7 150	4 620	
	Front blade and rear outrigger down (over rear)	*9 190	*9 190	*12 760	9 800	*9 430	6 360			7 060	4 710	
	4 outrigger down (over rear)	*9 190	*9 190	*12 760	11 760	*9 430	7 470			*7 150	5 490	
-3.0 m	Rear blade up (over front)	*15 190	10 140	8 160	5 440	5 390	3 690			4 880	3 360	6.49
	Rear blade down (over rear)	*15 190	11 770	*11 150	6 170	*8 220	4 150			*7 300	3 770	
	Rear outrigger down (over rear)	*15 190	14 770	*11 150	7 450	*8 220	4 950			*7 300	4 480	
	Front outrigger and rear blade down (over rear)	*15 190	*15 190	*11 150	9 700	*8 220	6 310			*7 300	5 690	
	Front blade and rear outrigger down (over rear)	*15 190	*15 190	*11 150	9 950	*8 220	6 450			*7 300	5 810	
	4 outrigger down (over rear)	*15 190	*15 190	*11 150	*11 150	*8 220	7 570			*7 300	6 790	



# MACHINE CAPACITIES

## ZX220W-7

- Notes:
1. Ratings are based on ISO 10567 : 2007.
  2. Machine capacity does not exceed 75% of tipping load with the machine on firm, level ground or 87% full hydraulic capacity.
  3. The load point is the center-line of the bucket pivot mounting pin on the arm.
  4. \*Indicates load limited by hydraulic capacity.
  5. Each value with Rear blade up over the Front-axle side and each value with Rear blade down over the Rear-axle side respectively, and value in optimal position with positioning cylinder.
  6. 0 m = Ground.

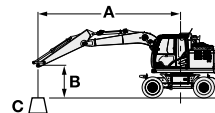

- A: Load radius  
B: Load point height  
C: Machine capacity

For machine capacities, subtract installed attachment and quick hitch weight from machine capacities.

To determine lifting capacities, apply "Rating over-side or 360 degrees" machine capacities from the table and deduct weight of installed attachment and quick hitch.



Optional feature may affect machine performance.











### ZX220W-7 MONOBLOCK BOOM, ARM 2.42 M, 5 000 KG COUNTERWEIGHT, STANDARD GAUGE

Rating over-front or rear Rating over-side or 360 degrees Unit : kg

Load point height (m)	Stabilization	Load radius								At max. reach		meter
		3.0 m		4.5 m		6.0 m		7.5 m				
6.0 m	Rear blade up (over front)					*6 380	4 390			4 920	3 240	7.23
	Rear blade down (over rear)					*6 380	4 870			*6 040	3 600	
	Rear outrigger down (over rear)					*6 380	5 630			*6 040	4 180	
	Front outrigger and rear blade down (over rear)					*6 380	*6 380			*6 040	5 180	
	Front blade and rear outrigger down (over rear)					*6 380	*6 380			*6 040	5 280	
	4 outrigger down (over rear)					*6 380	*6 380			*6 040	6 030	
4.5 m	Rear blade up (over front)			*8 810	6 340	6 420	4 200	4 580	3 000	4 210	2 740	7.91
	Rear blade down (over rear)			*8 810	7 090	*7 150	4 670	*6 430	3 340	*6 020	3 060	
	Rear outrigger down (over rear)			*8 810	8 310	*7 150	5 430	*6 430	3 880	*6 020	3 560	
	Front outrigger and rear blade down (over rear)			*8 810	*8 810	*7 150	6 760	*6 430	4 820	*6 020	4 430	
	Front blade and rear outrigger down (over rear)			*8 810	*8 810	*7 150	6 900	*6 430	4 920	*6 020	4 520	
	4 outrigger down (over rear)			*8 810	*8 810	*7 150	*7 150	*6 430	5 620	*6 020	5 170	
3.0 m	Rear blade up (over front)			9 250	5 740	6 140	3 950	4 460	2 890	3 870	2 500	8.26
	Rear blade down (over rear)			*11 400	6 470	*8 240	4 410	*6 870	3 230	*6 280	2 790	
	Rear outrigger down (over rear)			*11 400	7 660	*8 240	5 160	*6 870	3 770	6 060	3 270	
	Front outrigger and rear blade down (over rear)			*11 400	9 800	*8 240	6 480	*6 870	4 700	*6 280	4 080	
	Front blade and rear outrigger down (over rear)			*11 400	10 040	*8 240	6 610	*6 870	4 800	*6 280	4 160	
	4 outrigger down (over rear)			*11 400	*11 400	*8 240	7 630	*6 870	5 500	*6 280	4 770	
1.5 m	Rear blade up (over front)			8 780	5 330	5 890	3 720	4 340	2 780	3 770	2 410	8.3
	Rear blade down (over rear)			*11 770	6 050	*9 190	4 190	*7 320	3 110	*6 690	2 710	
	Rear outrigger down (over rear)			*11 770	7 220	*9 190	4 930	6 910	3 650	5 930	3 170	
	Front outrigger and rear blade down (over rear)			*11 770	9 330	*9 190	6 230	*7 320	4 580	*6 690	3 980	
	Front blade and rear outrigger down (over rear)			*11 770	9 560	*9 190	6 360	*7 320	4 680	6 480	4 060	
	4 outrigger down (over rear)			*11 770	11 280	*9 190	7 370	*7 320	5 380	6 670	4 660	
0 m (Ground)	Rear blade up (over front)			8 640	5 210	5 750	3 600	4 270	2 710	3 890	2 470	8.05
	Rear blade down (over rear)			*13 410	5 920	*9 640	4 050	*7 520	3 040	*6 920	2 780	
	Rear outrigger down (over rear)			*13 410	7 080	9 610	4 790	6 820	3 580	6 150	3 260	
	Front outrigger and rear blade down (over rear)			*13 410	9 180	*9 640	6 090	*7 520	4 510	*6 920	4 100	
	Front blade and rear outrigger down (over rear)			*13 410	9 410	*9 640	6 220	7 460	4 600	6 730	4 190	
	4 outrigger down (over rear)			*13 410	11 120	*9 640	7 220	*7 520	5 300	*6 920	4 820	
-1.5 m	Rear blade up (over front)	*9 190	*9 190	8 660	5 220	5 730	3 570			4 290	2 720	7.48
	Rear blade down (over rear)	*9 190	*9 190	*12 760	5 930	*9 430	4 030			*7 150	3 060	
	Rear outrigger down (over rear)	*9 190	*9 190	*12 760	7 100	*9 430	4 770			6 860	3 600	
	Front outrigger and rear blade down (over rear)	*9 190	*9 190	*12 760	9 200	*9 430	6 060			*7 150	4 530	
	Front blade and rear outrigger down (over rear)	*9 190	*9 190	*12 760	9 430	*9 430	6 190			*7 150	4 620	
	4 outrigger down (over rear)	*9 190	*9 190	*12 760	11 140	*9 430	7 190			*7 150	5 320	
-3.0 m	Rear blade up (over front)	*15 190	9 740	8 790	5 340	5 820	3 660			5 260	3 330	6.49
	Rear blade down (over rear)	*15 190	11 270	*11 150	6 060	*8 220	4 120			*7 300	3 750	
	Rear outrigger down (over rear)	*15 190	13 900	*11 150	7 230	*8 220	4 860			*7 300	4 410	
	Front outrigger and rear blade down (over rear)	*15 190	*15 190	*11 150	9 340	*8 220	6 150			*7 300	5 560	
	Front blade and rear outrigger down (over rear)	*15 190	*15 190	*11 150	9 570	*8 220	6 290			*7 300	5 680	
	4 outrigger down (over rear)	*15 190	*15 190	*11 150	*11 150	*8 220	7 290			*7 300	6 560	

**ZX220W-7 MONOBLOCK BOOM, ARM 2.42 M, 5 000 KG COUNTERWEIGHT, WIDE GAUGE**

 Rating over-front or rear  Rating over-side or 360 degrees Unit : kg

Load point height (m)	Stabilization	Load radius								At max. reach		
		3.0 m		4.5 m		6.0 m		7.5 m				meter
												
6.0 m	Rear blade up (over front)					*6 380	4 830			4 940	3 570	7.23
	Rear blade down (over rear)					*6 380	5 330			*6 040	3 950	
	Rear outrigger down (over rear)					*6 380	6 190			*6 040	4 590	
	Front outrigger and rear blade down (over rear)					*6 380	*6 380			*6 040	5 660	
	Front blade and rear outrigger down (over rear)					*6 380	*6 380			*6 040	5 770	
	4 outrigger down (over rear)					*6 380	*6 380			*6 040	*6 040	
4.5 m	Rear blade up (over front)			*8 810	7 020	6 450	4 630	4 600	3 310	4 230	3 030	7.91
	Rear blade down (over rear)			*8 810	7 830	*7 150	5 130	*6 430	3 670	*6 020	3 360	
	Rear outrigger down (over rear)			*8 810	*8 810	*7 150	5 980	*6 430	4 270	*6 020	3 920	
	Front outrigger and rear blade down (over rear)			*8 810	*8 810	*7 150	*7 150	*6 430	5 280	*6 020	4 850	
	Front blade and rear outrigger down (over rear)			*8 810	*8 810	*7 150	*7 150	*6 430	5 380	*6 020	4 950	
	4 outrigger down (over rear)			*8 810	*8 810	*7 150	*7 150	*6 430	6 190	*6 020	5 690	
3.0 m	Rear blade up (over front)			9 290	6 400	6 170	4 370	4 480	3 200	3 890	2 770	8.26
	Rear blade down (over rear)			*11 400	7 190	*8 240	4 870	*6 870	3 550	*6 280	3 080	
	Rear outrigger down (over rear)			*11 400	8 550	*8 240	5 710	*6 870	4 150	6 080	3 600	
	Front outrigger and rear blade down (over rear)			*11 400	10 920	*8 240	7 130	*6 870	5 160	*6 280	4 470	
	Front blade and rear outrigger down (over rear)			*11 400	11 190	*8 240	7 280	*6 870	5 260	*6 280	4 560	
	4 outrigger down (over rear)			*11 400	*11 400	*8 240	*8 240	*6 870	6 060	*6 280	5 250	
1.5 m	Rear blade up (over front)			8 830	5 990	5 920	4 150	4 370	3 090	3 790	2 680	8.3
	Rear blade down (over rear)			*11 770	6 760	*9 190	4 630	*7 320	3 440	*6 690	2 990	
	Rear outrigger down (over rear)			*11 770	8 100	*9 190	5 470	6 930	4 040	5 950	3 500	
	Front outrigger and rear blade down (over rear)			*11 770	10 430	*9 190	6 880	*7 320	5 040	*6 690	4 370	
	Front blade and rear outrigger down (over rear)			*11 770	10 690	*9 190	7 030	*7 320	5 140	6 510	4 460	
	4 outrigger down (over rear)			*11 770	*11 770	*9 190	8 190	*7 320	5 940	*6 690	5 140	
0 m (Ground)	Rear blade up (over front)			8 680	5 860	5 780	4 020	4 290	3 010	3 910	2 750	8.05
	Rear blade down (over rear)			*13 410	6 620	*9 640	4 500	*7 520	3 360	*6 920	3 070	
	Rear outrigger down (over rear)			*13 410	7 950	9 630	5 330	6 840	3 960	6 170	3 610	
	Front outrigger and rear blade down (over rear)			*13 410	10 280	*9 640	6 730	*7 520	4 960	*6 920	4 510	
	Front blade and rear outrigger down (over rear)			*13 410	10 540	*9 640	6 880	7 490	5 060	6 760	4 600	
	4 outrigger down (over rear)			*13 410	12 580	*9 640	8 040	*7 520	5 860	*6 920	5 310	
-1.5 m	Rear blade up (over front)	*9 190	*9 190	8 700	5 870	5 750	3 990			4 310	3 030	7.48
	Rear blade down (over rear)	*9 190	*9 190	*12 760	6 640	*9 430	4 470			*7 150	3 380	
	Rear outrigger down (over rear)	*9 190	*9 190	*12 760	7 970	*9 430	5 300			6 880	3 980	
	Front outrigger and rear blade down (over rear)	*9 190	*9 190	*12 760	10 300	*9 430	6 700			*7 150	4 980	
	Front blade and rear outrigger down (over rear)	*9 190	*9 190	*12 760	10 560	*9 430	6 850			*7 150	5 090	
	4 outrigger down (over rear)	*9 190	*9 190	*12 760	12 600	*9 430	8 010			*7 150	5 890	
-3.0 m	Rear blade up (over front)	*15 190	11 120	8 830	5 990	5 850	4 080			5 290	3 710	6.49
	Rear blade down (over rear)	*15 190	12 840	*11 150	6 760	*8 220	4 560			*7 300	4 140	
	Rear outrigger down (over rear)	*15 190	*15 190	*11 150	8 100	*8 220	5 390			*7 300	4 880	
	Front outrigger and rear blade down (over rear)	*15 190	*15 190	*11 150	10 440	*8 220	6 800			*7 300	6 130	
	Front blade and rear outrigger down (over rear)	*15 190	*15 190	*11 150	10 700	*8 220	6 950			*7 300	6 260	
	4 outrigger down (over rear)	*15 190	*15 190	*11 150	*11 150	*8 220	8 110			*7 300	7 270	



# MACHINE CAPACITIES

## ZX220W-7

- Notes:
1. Ratings are based on ISO 10567 : 2007.
  2. Machine capacity does not exceed 75% of tipping load with the machine on firm, level ground or 87% full hydraulic capacity.
  3. The load point is the center-line of the bucket pivot mounting pin on the arm.
  4. \*Indicates load limited by hydraulic capacity.
  5. Each value with Rear blade up over the Front-axle side and each value with Rear blade down over the Rear-axle side respectively, and value in optimal position with positioning cylinder.
  6. 0 m = Ground.

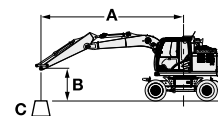

- A: Load radius  
B: Load point height  
C: Machine capacity

For machine capacities, subtract installed attachment and quick hitch weight from machine capacities.

To determine lifting capacities, apply "Rating over-side or 360 degrees" machine capacities from the table and deduct weight of installed attachment and quick hitch.

Optional feature may affect machine performance.

### ZX220W-7 MONOBLOCK BOOM, ARM 2.91 M, 2 600 KG COUNTERWEIGHT, STANDARD GAUGE

Rating over-front or rear Rating over-side or 360 degrees Unit : kg

Load point height (m)	Stabilization	Load radius								At max. reach		
		3.0 m		4.5 m		6.0 m		7.5 m				meter
6.0 m	Rear blade up (over front)					5 150	3 200	3 520	2 130	3 280	1 960	7.79
	Rear blade down (over rear)					*5 790	3 610	*5 010	2 420	*4 000	2 240	
	Rear outrigger down (over rear)					*5 790	4 270	*5 010	2 900	*4 000	2 690	
	Front outrigger and rear blade down (over rear)					*5 790	5 460	*5 010	3 740	*4 000	3 480	
	Front blade and rear outrigger down (over rear)					*5 790	5 580	*5 010	3 820	*4 000	3 560	
	4 outrigger down (over rear)					*5 790	*5 790	*5 010	4 450	*4 000	*4 000	
4.5 m	Rear blade up (over front)			7 820	4 710	4 940	3 010	3 450	2 060	2 810	1 640	8.43
	Rear blade down (over rear)			*7 880	5 350	*6 620	3 410	*6 020	2 350	*3 970	1 890	
	Rear outrigger down (over rear)			*7 880	6 400	*6 620	4 070	5 630	2 830	*3 970	2 290	
	Front outrigger and rear blade down (over rear)			*7 880	*7 880	*6 620	5 240	*6 020	3 660	*3 970	3 000	
	Front blade and rear outrigger down (over rear)			*7 880	*7 880	*6 620	5 360	*6 020	3 740	*3 970	3 070	
	4 outrigger down (over rear)			*7 880	*7 880	*6 620	6 260	*6 020	4 370	*3 970	3 590	
3.0 m	Rear blade up (over front)			7 130	4 110	4 650	2 740	3 310	1 930	2 580	1 470	8.76
	Rear blade down (over rear)			*10 520	4 730	*7 780	3 140	6 420	2 220	*4 100	1 700	
	Rear outrigger down (over rear)			*10 520	5 750	*7 780	3 790	5 480	2 700	*4 100	2 080	
	Front outrigger and rear blade down (over rear)			*10 520	7 620	*7 780	4 950	*6 550	3 530	*4 100	2 750	
	Front blade and rear outrigger down (over rear)			*10 520	7 820	*7 780	5 060	6 110	3 610	*4 100	2 820	
	4 outrigger down (over rear)			*10 520	9 340	*7 780	5 950	6 330	4 230	*4 100	3 310	
1.5 m	Rear blade up (over front)			6 580	3 630	4 370	2 490	3 170	1 810	2 500	1 390	8.8
	Rear blade down (over rear)			*12 620	4 230	*8 870	2 890	6 250	2 090	*4 400	1 630	
	Rear outrigger down (over rear)			12 600	5 230	7 600	3 530	5 320	2 560	4 150	2 010	
	Front outrigger and rear blade down (over rear)			*12 620	7 060	*8 870	4 670	*7 100	3 390	*4 400	2 670	
	Front blade and rear outrigger down (over rear)			*12 620	7 260	8 480	4 790	5 950	3 470	*4 400	2 730	
	4 outrigger down (over rear)			*12 620	8 740	8 780	5 670	6 170	4 090	*4 400	3 220	
0 m (Ground)	Rear blade up (over front)			6 340	3 410	4 200	2 330	3 080	1 710	2 560	1 410	8.56
	Rear blade down (over rear)			*13 390	4 010	8 850	2 720	6 130	2 000	*4 950	1 660	
	Rear outrigger down (over rear)			12 280	5 000	7 390	3 360	5 210	2 470	4 270	2 050	
	Front outrigger and rear blade down (over rear)			*13 390	6 810	*9 520	4 490	7 070	3 290	*4 950	2 730	
	Front blade and rear outrigger down (over rear)			*13 390	7 010	8 270	4 610	5 840	3 370	4 800	2 800	
	4 outrigger down (over rear)			*13 390	8 480	8 570	5 480	6 060	3 980	*4 950	3 300	
-1.5 m	Rear blade up (over front)	*8 340	6 280	6 300	3 380	4 130	2 270	3 040	1 680	2 790	1 550	8.03
	Rear blade down (over rear)	*8 340	7 510	*13 090	3 970	8 760	2 660	6 100	1 970	5 510	1 810	
	Rear outrigger down (over rear)	*8 340	*8 340	12 220	4 960	7 310	3 290	5 170	2 440	4 690	2 230	
	Front outrigger and rear blade down (over rear)	*8 340	*8 340	*13 090	6 770	*9 540	4 430	7 030	3 260	*5 940	2 980	
	Front blade and rear outrigger down (over rear)	*8 340	*8 340	*13 090	6 970	8 190	4 540	5 800	3 340	5 270	3 050	
	4 outrigger down (over rear)	*8 340	*8 340	*13 090	8 430	8 490	5 410	6 020	3 950	5 460	3 610	
-3.0 m	Rear blade up (over front)	12 970	6 460	6 390	3 460	4 180	2 320			3 330	1 870	7.12
	Rear blade down (over rear)	*14 010	7 700	*11 850	4 060	*8 740	2 700			6 700	2 180	
	Rear outrigger down (over rear)	*14 010	9 850	*11 850	5 050	7 370	3 340			5 670	2 680	
	Front outrigger and rear blade down (over rear)	*14 010	*14 010	*11 850	6 870	*8 740	4 480			*6 850	3 560	
	Front blade and rear outrigger down (over rear)	*14 010	*14 010	*11 850	7 060	8 250	4 590			6 350	3 650	
	4 outrigger down (over rear)	*14 010	*14 010	*11 850	8 530	8 550	5 460			6 590	4 320	
-4.5 m	Rear blade up (over front)			6 640	3 680					4 790	2 730	5.64
	Rear blade down (over rear)			*9 110	4 280					*6 800	3 160	
	Rear outrigger down (over rear)			*9 110	5 280					*6 800	3 860	
	Front outrigger and rear blade down (over rear)			*9 110	7 120					*6 800	5 120	
	Front blade and rear outrigger down (over rear)			*9 110	7 310					*6 800	5 250	
	4 outrigger down (over rear)			*9 110	8 800					*6 800	6 230	

**ZX220W-7 MONOBLOCK BOOM, ARM 2.91 M, 2 600 KG COUNTERWEIGHT, WIDE GAUGE**

Rating over-front or rear Rating over-side or 360 degrees Unit : kg

Load point height (m)	Stabilization	Load radius								At max. reach		meter
		3.0 m		4.5 m		6.0 m		7.5 m				
6.0 m	Rear blade up (over front)					5 180	3 580	3 540	2 400	3 300	2 220	7.79
	Rear blade down (over rear)					*5 790	4 010	*5 010	2 710	*4 000	2 510	
	Rear outrigger down (over rear)					*5 790	4 750	*5 010	3 240	*4 000	3 010	
	Front outrigger and rear blade down (over rear)					*5 790	*5 790	*5 010	4 140	*4 000	3 860	
	Front blade and rear outrigger down (over rear)					*5 790	*5 790	*5 010	4 230	*4 000	3 950	
	4 outrigger down (over rear)					*5 790	*5 790	*5 010	4 950	*4 000	*4 000	
4.5 m	Rear blade up (over front)			7 860	5 290	4 960	3 380	3 470	2 330	2 830	1 870	8.43
	Rear blade down (over rear)			*7 880	5 980	*6 620	3 800	*6 020	2 630	*3 970	2 130	
	Rear outrigger down (over rear)			*7 880	7 190	*6 620	4 540	5 650	3 160	*3 970	2 570	
	Front outrigger and rear blade down (over rear)			*7 880	*7 880	*6 620	5 820	*6 020	4 060	*3 970	3 330	
	Front blade and rear outrigger down (over rear)			*7 880	*7 880	*6 620	5 950	*6 020	4 150	*3 970	3 410	
	4 outrigger down (over rear)			*7 880	*7 880	*6 620	*6 620	*6 020	4 870	*3 970	*3 970	
3.0 m	Rear blade up (over front)			7 170	4 670	4 670	3 110	3 330	2 200	2 600	1 680	8.76
	Rear blade down (over rear)			*10 520	5 340	*7 780	3 530	6 440	2 510	*4 100	1 930	
	Rear outrigger down (over rear)			*10 520	6 510	*7 780	4 260	5 500	3 030	*4 100	2 350	
	Front outrigger and rear blade down (over rear)			*10 520	8 590	*7 780	5 520	*6 550	3 930	*4 100	3 070	
	Front blade and rear outrigger down (over rear)			*10 520	8 810	*7 780	5 650	6 140	4 020	*4 100	3 140	
	4 outrigger down (over rear)			*10 520	*10 520	*7 780	6 680	6 380	4 720	*4 100	3 700	
1.5 m	Rear blade up (over front)			6 620	4 180	4 400	2 850	3 200	2 070	2 520	1 610	8.8
	Rear blade down (over rear)			*12 620	4 820	*8 870	3 270	6 270	2 370	*4 400	1 850	
	Rear outrigger down (over rear)			*12 620	5 970	7 620	3 990	5 340	2 900	4 160	2 270	
	Front outrigger and rear blade down (over rear)			*12 620	8 010	*8 870	5 240	*7 100	3 780	*4 400	2 980	
	Front blade and rear outrigger down (over rear)			*12 620	8 230	8 530	5 360	5 990	3 870	*4 400	3 050	
	4 outrigger down (over rear)			*12 620	9 990	8 850	6 380	6 220	4 580	*4 400	3 610	
0 m (Ground)	Rear blade up (over front)			6 380	3 960	4 230	2 690	3 100	1 980	2 570	1 640	8.56
	Rear blade down (over rear)			*13 390	4 600	8 880	3 100	6 160	2 280	*4 950	1 890	
	Rear outrigger down (over rear)			12 320	5 730	7 410	3 820	5 230	2 800	4 290	2 320	
	Front outrigger and rear blade down (over rear)			*13 390	7 750	*9 520	5 050	7 130	3 680	*4 950	3 060	
	Front blade and rear outrigger down (over rear)			*13 390	7 970	8 320	5 180	5 870	3 770	4 830	3 130	
	4 outrigger down (over rear)			*13 390	9 720	8 640	6 190	6 110	4 470	*4 950	3 700	
-1.5 m	Rear blade up (over front)	*8 340	7 390	6 340	3 920	4 160	2 630	3 070	1 950	2 810	1 790	8.03
	Rear blade down (over rear)	*8 340	*8 340	*13 090	4 560	8 790	3 040	6 120	2 250	5 530	2 060	
	Rear outrigger down (over rear)	*8 340	*8 340	12 270	5 690	7 340	3 750	5 190	2 770	4 710	2 530	
	Front outrigger and rear blade down (over rear)	*8 340	*8 340	*13 090	7 710	*9 540	4 990	7 090	3 650	*5 940	3 340	
	Front blade and rear outrigger down (over rear)	*8 340	*8 340	*13 090	7 930	8 240	5 110	5 840	3 740	5 300	3 420	
	4 outrigger down (over rear)	*8 340	*8 340	*13 090	9 670	8 570	6 120	6 070	4 440	5 510	4 050	
-3.0 m	Rear blade up (over front)	13 050	7 580	6 430	4 010	4 210	2 670			3 360	2 150	7.12
	Rear blade down (over rear)	*14 010	8 970	*11 850	4 650	*8 740	3 080			6 720	2 480	
	Rear outrigger down (over rear)	*14 010	11 570	*11 850	5 780	7 390	3 800			5 690	3 040	
	Front outrigger and rear blade down (over rear)	*14 010	*14 010	*11 850	7 800	*8 740	5 030			*6 850	3 990	
	Front blade and rear outrigger down (over rear)	*14 010	*14 010	*11 850	8 020	8 300	5 160			6 390	4 090	
	4 outrigger down (over rear)	*14 010	*14 010	*11 850	9 780	8 620	6 170			6 640	4 850	
-4.5 m	Rear blade up (over front)			6 680	4 230					4 820	3 120	5.64
	Rear blade down (over rear)			*9 110	4 880					*6 800	3 580	
	Rear outrigger down (over rear)			*9 110	6 020					*6 800	4 370	
	Front outrigger and rear blade down (over rear)			*9 110	8 070					*6 800	5 750	
	Front blade and rear outrigger down (over rear)			*9 110	8 290					*6 800	5 890	
	4 outrigger down (over rear)			*9 110	*9 110					*6 800	*6 800	



# MACHINE CAPACITIES

## ZX220W-7

- Notes:
1. Ratings are based on ISO 10567 : 2007.
  2. Machine capacity does not exceed 75% of tipping load with the machine on firm, level ground or 87% full hydraulic capacity.
  3. The load point is the center-line of the bucket pivot mounting pin on the arm.
  4. \*Indicates load limited by hydraulic capacity.
  5. Each value with Rear blade up over the Front-axle side and each value with Rear blade down over the Rear-axle side respectively, and value in optimal position with positioning cylinder.
  6. 0 m = Ground.

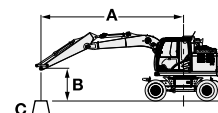

- A: Load radius  
B: Load point height  
C: Machine capacity

For machine capacities, subtract installed attachment and quick hitch weight from machine capacities.

To determine lifting capacities, apply "Rating over-side or 360 degrees" machine capacities from the table and deduct weight of installed attachment and quick hitch.

Optional feature may affect machine performance.

### ZX220W-7 MONOBLOCK BOOM, ARM 2.91 M, 4 300 KG COUNTERWEIGHT, STANDARD GAUGE

Rating over-front or rear Rating over-side or 360 degrees Unit : kg

Load point height (m)	Stabilization	Load radius								At max. reach		
		3.0 m		4.5 m		6.0 m		7.5 m				meter
6.0 m	Rear blade up (over front)					*5 790	4 090	4 350	2 820	*4 000	2 620	7.79
	Rear blade down (over rear)					*5 790	4 550	*5 010	3 140	*4 000	2 930	
	Rear outrigger down (over rear)					*5 790	5 290	*5 010	3 670	*4 000	3 430	
	Front outrigger and rear blade down (over rear)					*5 790	*5 790	*5 010	4 580	*4 000	*4 000	
	Front blade and rear outrigger down (over rear)					*5 790	*5 790	*5 010	4 680	*4 000	*4 000	
	4 outrigger down (over rear)					*5 790	*5 790	*5 010	*5 010	*4 000	*4 000	
4.5 m	Rear blade up (over front)			*7 880	5 980	6 040	3 900	4 270	2 750	3 530	2 240	8.43
	Rear blade down (over rear)			*7 880	6 700	*6 620	4 350	*6 020	3 070	*3 970	2 520	
	Rear outrigger down (over rear)			*7 880	*7 880	*6 620	5 080	*6 020	3 600	*3 970	2 960	
	Front outrigger and rear blade down (over rear)			*7 880	*7 880	*6 620	6 370	*6 020	4 510	*3 970	3 730	
	Front blade and rear outrigger down (over rear)			*7 880	*7 880	*6 620	6 500	*6 020	4 600	*3 970	3 810	
	4 outrigger down (over rear)			*7 880	*7 880	*6 620	*6 620	*6 020	5 280	*3 970	*3 970	
3.0 m	Rear blade up (over front)			8 760	5 380	5 750	3 630	4 140	2 620	3 270	2 040	8.76
	Rear blade down (over rear)			*10 520	6 080	*7 780	4 080	*6 550	2 950	*4 100	2 310	
	Rear outrigger down (over rear)			*10 520	7 230	*7 780	4 800	*6 550	3 470	*4 100	2 730	
	Front outrigger and rear blade down (over rear)			*10 520	9 300	*7 780	6 070	*6 550	4 370	*4 100	3 450	
	Front blade and rear outrigger down (over rear)			*10 520	9 530	*7 780	6 210	*6 550	4 470	*4 100	3 530	
	4 outrigger down (over rear)			*10 520	*10 520	*7 780	7 190	*6 550	5 150	*4 100	4 070	
1.5 m	Rear blade up (over front)			8 210	4 900	5 470	3 380	4 000	2 490	3 180	1 970	8.8
	Rear blade down (over rear)			*12 620	5 580	*8 870	3 830	*7 100	2 820	*4 400	2 230	
	Rear outrigger down (over rear)			*12 620	6 710	*8 870	4 540	6 450	3 330	*4 400	2 650	
	Front outrigger and rear blade down (over rear)			*12 620	8 740	*8 870	5 800	*7 100	4 240	*4 400	3 370	
	Front blade and rear outrigger down (over rear)			*12 620	8 960	*8 870	5 930	7 080	4 330	*4 400	3 440	
	4 outrigger down (over rear)			*12 620	10 620	*8 870	6 900	*7 100	5 000	*4 400	3 970	
0 m (Ground)	Rear blade up (over front)			7 970	4 680	5 300	3 220	3 910	2 400	3 260	2 010	8.56
	Rear blade down (over rear)			*13 390	5 360	*9 520	3 660	7 380	2 720	*4 950	2 280	
	Rear outrigger down (over rear)			*13 390	6 480	8 960	4 370	6 340	3 240	*4 950	2 710	
	Front outrigger and rear blade down (over rear)			*13 390	8 500	*9 520	5 620	*7 440	4 140	*4 950	3 450	
	Front blade and rear outrigger down (over rear)			*13 390	8 710	*9 520	5 750	6 970	4 230	*4 950	3 530	
	4 outrigger down (over rear)			*13 390	10 360	*9 520	6 710	7 190	4 900	*4 950	4 080	
-1.5 m	Rear blade up (over front)	*8 340	*8 340	7 930	4 650	5 230	3 170	3 870	2 370	3 550	2 180	8.03
	Rear blade down (over rear)	*8 340	*8 340	*13 090	5 330	*9 540	3 600	*7 340	2 690	*5 940	2 480	
	Rear outrigger down (over rear)	*8 340	*8 340	*13 090	6 440	8 880	4 310	6 300	3 210	5 720	2 940	
	Front outrigger and rear blade down (over rear)	*8 340	*8 340	*13 090	8 450	*9 540	5 560	*7 340	4 100	*5 940	3 760	
	Front blade and rear outrigger down (over rear)	*8 340	*8 340	*13 090	8 670	*9 540	5 680	6 940	4 190	*5 940	3 840	
	4 outrigger down (over rear)	*8 340	*8 340	*13 090	10 310	*9 540	6 650	7 150	4 870	*5 940	4 450	
-3.0 m	Rear blade up (over front)	*14 010	8 660	8 020	4 730	5 280	3 210			4 220	2 600	7.12
	Rear blade down (over rear)	*14 010	10 100	*11 850	5 410	*8 740	3 650			*6 850	2 950	
	Rear outrigger down (over rear)	*14 010	12 580	*11 850	6 530	*8 740	4 350			*6 850	3 500	
	Front outrigger and rear blade down (over rear)	*14 010	*14 010	*11 850	8 550	*8 740	5 600			*6 850	4 470	
	Front blade and rear outrigger down (over rear)	*14 010	*14 010	*11 850	8 770	*8 740	5 730			*6 850	4 570	
	4 outrigger down (over rear)	*14 010	*14 010	*11 850	10 410	*8 740	6 690			*6 850	5 300	
-4.5 m	Rear blade up (over front)			8 270	4 950					5 990	3 690	5.64
	Rear blade down (over rear)			*9 110	5 630					*6 800	4 170	
	Rear outrigger down (over rear)			*9 110	6 760					*6 800	4 960	
	Front outrigger and rear blade down (over rear)			*9 110	8 800					*6 800	6 350	
	Front blade and rear outrigger down (over rear)			*9 110	9 020					*6 800	6 490	
	4 outrigger down (over rear)			*9 110	*9 110					*6 800	*6 800	

**ZX220W-7 MONOBLOCK BOOM, ARM 2.91 M, 4 300 KG COUNTERWEIGHT, WIDE GAUGE**

Rating over-front or rear Rating over-side or 360 degrees Unit : kg

Load point height (m)	Stabilization	Load radius								At max. reach		
		3.0 m		4.5 m		6.0 m		7.5 m				meter
6.0 m	Rear blade up (over front)					*5 790	4 510	4 370	3 120	*4 000	2 910	7.79
	Rear blade down (over rear)					*5 790	4 990	*5 010	3 460	*4 000	3 230	
	Rear outrigger down (over rear)					*5 790	*5 790	*5 010	4 050	*4 000	3 780	
	Front outrigger and rear blade down (over rear)					*5 790	*5 790	*5 010	*5 010	*4 000	*4 000	
	Front blade and rear outrigger down (over rear)					*5 790	*5 790	*5 010	*5 010	*4 000	*4 000	
	4 outrigger down (over rear)					*5 790	*5 790	*5 010	*5 010	*4 000	*4 000	
4.5 m	Rear blade up (over front)			*7 880	6 640	6 070	4 310	4 300	3 050	3 550	2 490	8.43
	Rear blade down (over rear)			*7 880	7 410	*6 620	4 790	*6 020	3 390	*3 970	2 780	
	Rear outrigger down (over rear)			*7 880	*7 880	*6 620	5 610	*6 020	3 970	*3 970	3 280	
	Front outrigger and rear blade down (over rear)			*7 880	*7 880	*6 620	*6 620	*6 020	4 950	*3 970	*3 970	
	Front blade and rear outrigger down (over rear)			*7 880	*7 880	*6 620	*6 620	*6 020	5 050	*3 970	*3 970	
	4 outrigger down (over rear)			*7 880	*7 880	*6 620	*6 620	*6 020	5 830	*3 970	*3 970	
3.0 m	Rear blade up (over front)			8 810	6 020	5 770	4 040	4 160	2 920	3 290	2 280	8.76
	Rear blade down (over rear)			*10 520	6 770	*7 780	4 510	*6 550	3 260	*4 100	2 560	
	Rear outrigger down (over rear)			*10 520	8 090	*7 780	5 330	*6 550	3 840	*4 100	3 020	
	Front outrigger and rear blade down (over rear)			*10 520	10 390	*7 780	6 710	*6 550	4 810	*4 100	3 800	
	Front blade and rear outrigger down (over rear)			*10 520	*10 520	*7 780	6 850	*6 550	4 910	*4 100	3 880	
	4 outrigger down (over rear)			*10 520	*10 520	*7 780	*7 780	*6 550	5 690	*4 100	*4 100	
1.5 m	Rear blade up (over front)			8 250	5 520	5 500	3 790	4 030	2 790	3 200	2 210	8.8
	Rear blade down (over rear)			*12 620	6 260	*8 870	4 260	*7 100	3 130	*4 400	2 480	
	Rear outrigger down (over rear)			*12 620	7 550	*8 870	5 060	6 470	3 700	*4 400	2 940	
	Front outrigger and rear blade down (over rear)			*12 620	9 800	*8 870	6 420	*7 100	4 670	*4 400	3 710	
	Front blade and rear outrigger down (over rear)			*12 620	10 050	*8 870	6 570	*7 100	4 770	*4 400	3 790	
	4 outrigger down (over rear)			*12 620	12 020	*8 870	7 690	*7 100	5 540	*4 400	4 390	
0 m (Ground)	Rear blade up (over front)			8 010	5 300	5 330	3 630	3 930	2 700	3 280	2 250	8.56
	Rear blade down (over rear)			*13 390	6 030	*9 520	4 090	7 400	3 030	*4 950	2 530	
	Rear outrigger down (over rear)			*13 390	7 310	8 990	4 880	6 360	3 610	*4 950	3 010	
	Front outrigger and rear blade down (over rear)			*13 390	9 550	*9 520	6 240	*7 440	4 570	*4 950	3 810	
	Front blade and rear outrigger down (over rear)			*13 390	9 790	*9 520	6 380	7 010	4 670	*4 950	3 890	
	4 outrigger down (over rear)			*13 390	11 750	*9 520	7 500	7 240	5 440	*4 950	4 520	
-1.5 m	Rear blade up (over front)	*8 340	*8 340	7 970	5 270	5 260	3 570	3 900	2 670	3 570	2 450	8.03
	Rear blade down (over rear)	*8 340	*8 340	*13 090	5 990	*9 540	4 030	*7 340	3 000	*5 940	2 760	
	Rear outrigger down (over rear)	*8 340	*8 340	*13 090	7 270	8 910	4 820	6 320	3 580	5 740	3 280	
	Front outrigger and rear blade down (over rear)	*8 340	*8 340	*13 090	9 510	*9 540	6 170	*7 340	4 540	*5 940	4 150	
	Front blade and rear outrigger down (over rear)	*8 340	*8 340	*13 090	9 750	*9 540	6 320	6 970	4 640	*5 940	4 240	
	4 outrigger down (over rear)	*8 340	*8 340	*13 090	11 700	*9 540	7 430	7 210	5 410	*5 940	4 930	
-3.0 m	Rear blade up (over front)	*14 010	9 960	8 060	5 350	5 310	3 610			4 240	2 920	7.12
	Rear blade down (over rear)	*14 010	11 580	*11 850	6 080	*8 740	4 070			*6 850	3 280	
	Rear outrigger down (over rear)	*14 010	*14 010	*11 850	7 360	*8 740	4 870			*6 850	3 900	
	Front outrigger and rear blade down (over rear)	*14 010	*14 010	*11 850	9 600	*8 740	6 220			*6 850	4 940	
	Front blade and rear outrigger down (over rear)	*14 010	*14 010	*11 850	9 850	*8 740	6 370			*6 850	5 050	
	4 outrigger down (over rear)	*14 010	*14 010	*11 850	11 810	*8 740	7 480			*6 850	5 890	
-4.5 m	Rear blade up (over front)			8 310	5 570					6 020	4 130	5.64
	Rear blade down (over rear)			*9 110	6 310					*6 800	4 640	
	Rear outrigger down (over rear)			*9 110	7 600					*6 800	5 530	
	Front outrigger and rear blade down (over rear)			*9 110	*9 110					*6 800	*6 800	
	Front blade and rear outrigger down (over rear)			*9 110	*9 110					*6 800	*6 800	
	4 outrigger down (over rear)			*9 110	*9 110					*6 800	*6 800	



# MACHINE CAPACITIES

## ZX220W-7

- Notes:
1. Ratings are based on ISO 10567 : 2007.
  2. Machine capacity does not exceed 75% of tipping load with the machine on firm, level ground or 87% full hydraulic capacity.
  3. The load point is the center-line of the bucket pivot mounting pin on the arm.
  4. \*Indicates load limited by hydraulic capacity.
  5. Each value with Rear blade up over the Front-axle side and each value with Rear blade down over the Rear-axle side respectively, and value in optimal position with positioning cylinder.
  6. 0 m = Ground.

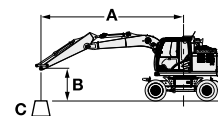

- A: Load radius  
B: Load point height  
C: Machine capacity

For machine capacities, subtract installed attachment and quick hitch weight from machine capacities.

To determine lifting capacities, apply "Rating over-side or 360 degrees" machine capacities from the table and deduct weight of installed attachment and quick hitch.

Optional feature may affect machine performance.











### ZX220W-7 MONOBLOCK BOOM, ARM 2.91 M, 5 000 KG COUNTERWEIGHT, STANDARD GAUGE

Rating over-front or rear Rating over-side or 360 degrees Unit : kg

Load point height (m)	Stabilization	Load radius								At max. reach		
		3.0 m		4.5 m		6.0 m		7.5 m				meter
6.0 m	Rear blade up (over front)					*5 790	4 460	4 690	3 100	*4 000	2 890	7.79
	Rear blade down (over rear)					*5 790	4 940	*5 010	3 440	*4 000	3 220	
	Rear outrigger down (over rear)					*5 790	5 710	*5 010	3 990	*4 000	3 730	
	Front outrigger and rear blade down (over rear)					*5 790	*5 790	*5 010	4 930	*4 000	*4 000	
	Front blade and rear outrigger down (over rear)					*5 790	*5 790	*5 010	*5 010	*4 000	*4 000	
	4 outrigger down (over rear)					*5 790	*5 790	*5 010	*5 010	*4 000	*4 000	
4.5 m	Rear blade up (over front)			*7 880	6 500	6 490	4 260	4 620	3 030	3 830	2 490	8.43
	Rear blade down (over rear)			*7 880	7 260	*6 620	4 740	*6 020	3 370	*3 970	2 780	
	Rear outrigger down (over rear)			*7 880	*7 880	*6 620	5 500	*6 020	3 920	*3 970	3 240	
	Front outrigger and rear blade down (over rear)			*7 880	*7 880	*6 620	*6 620	*6 020	4 860	*3 970	*3 970	
	Front blade and rear outrigger down (over rear)			*7 880	*7 880	*6 620	*6 620	*6 020	4 950	*3 970	*3 970	
	4 outrigger down (over rear)			*7 880	*7 880	*6 620	*6 620	*6 020	5 660	*3 970	*3 970	
3.0 m	Rear blade up (over front)			9 440	5 900	6 200	4 000	4 480	2 900	3 550	2 280	8.76
	Rear blade down (over rear)			*10 520	6 640	*7 780	4 470	*6 550	3 240	*4 100	2 550	
	Rear outrigger down (over rear)			*10 520	7 840	*7 780	5 220	*6 550	3 790	*4 100	2 990	
	Front outrigger and rear blade down (over rear)			*10 520	9 990	*7 780	6 540	*6 550	4 720	*4 100	3 740	
	Front blade and rear outrigger down (over rear)			*10 520	10 230	*7 780	6 680	*6 550	4 820	*4 100	3 820	
	4 outrigger down (over rear)			*10 520	*10 520	*7 780	7 690	*6 550	5 520	*4 100	*4 100	
1.5 m	Rear blade up (over front)			8 890	5 420	5 930	3 750	4 350	2 780	3 460	2 200	8.8
	Rear blade down (over rear)			*12 620	6 140	*8 870	4 210	*7 100	3 110	*4 400	2 480	
	Rear outrigger down (over rear)			*12 620	7 320	*8 870	4 960	6 920	3 650	*4 400	2 910	
	Front outrigger and rear blade down (over rear)			*12 620	9 430	*8 870	6 260	*7 100	4 580	*4 400	3 660	
	Front blade and rear outrigger down (over rear)			*12 620	9 670	*8 870	6 400	*7 100	4 680	*4 400	3 730	
	4 outrigger down (over rear)			*12 620	11 390	*8 870	7 410	*7 100	5 380	*4 400	4 280	
0 m (Ground)	Rear blade up (over front)			8 640	5 210	5 750	3 590	4 250	2 680	3 550	2 250	8.56
	Rear blade down (over rear)			*13 390	5 920	*9 520	4 050	*7 440	3 020	*4 950	2 530	
	Rear outrigger down (over rear)			*13 390	7 090	*9 520	4 790	6 810	3 560	*4 950	2 980	
	Front outrigger and rear blade down (over rear)			*13 390	9 190	*9 520	6 080	*7 440	4 480	*4 950	3 750	
	Front blade and rear outrigger down (over rear)			*13 390	9 420	*9 520	6 220	7 440	4 580	*4 950	3 830	
	4 outrigger down (over rear)			*13 390	11 130	*9 520	7 220	*7 440	5 280	*4 950	4 400	
-1.5 m	Rear blade up (over front)	*8 340	*8 340	8 600	5 170	5 690	3 530	4 220	2 650	3 870	2 440	8.03
	Rear blade down (over rear)	*8 340	*8 340	*13 090	5 880	*9 540	3 990	*7 340	2 990	*5 940	2 750	
	Rear outrigger down (over rear)	*8 340	*8 340	*13 090	7 050	9 530	4 730	6 770	3 530	*5 940	3 240	
	Front outrigger and rear blade down (over rear)	*8 340	*8 340	*13 090	9 150	*9 540	6 020	*7 340	4 450	*5 940	4 080	
	Front blade and rear outrigger down (over rear)	*8 340	*8 340	*13 090	9 380	*9 540	6 150	*7 340	4 550	*5 940	4 170	
	4 outrigger down (over rear)	*8 340	*8 340	*13 090	11 090	*9 540	7 150	*7 340	5 240	*5 940	4 800	
-3.0 m	Rear blade up (over front)	*14 010	9 570	8 690	5 250	5 730	3 570			4 580	2 900	7.12
	Rear blade down (over rear)	*14 010	11 090	*11 850	5 970	*8 740	4 030			*6 850	3 260	
	Rear outrigger down (over rear)	*14 010	13 700	*11 850	7 130	*8 740	4 770			*6 850	3 840	
	Front outrigger and rear blade down (over rear)	*14 010	*14 010	*11 850	9 240	*8 740	6 070			*6 850	4 840	
	Front blade and rear outrigger down (over rear)	*14 010	*14 010	*11 850	9 470	*8 740	6 200			*6 850	4 940	
	4 outrigger down (over rear)	*14 010	*14 010	*11 850	11 190	*8 740	7 200			*6 850	5 700	
-4.5 m	Rear blade up (over front)			8 940	5 470					6 480	4 080	5.64
	Rear blade down (over rear)			*9 110	6 190					*6 800	4 590	
	Rear outrigger down (over rear)			*9 110	7 370					*6 800	5 410	
	Front outrigger and rear blade down (over rear)			*9 110	*9 110					*6 800	*6 800	
	Front blade and rear outrigger down (over rear)			*9 110	*9 110					*6 800	*6 800	
	4 outrigger down (over rear)			*9 110	*9 110					*6 800	*6 800	

**ZX220W-7 MONOBLOCK BOOM, ARM 2.91 M, 5 000 KG COUNTERWEIGHT, WIDE GAUGE**

 Rating over-front or rear  Rating over-side or 360 degrees Unit : kg

Load point height (m)	Stabilization	Load radius								At max. reach		
		3.0 m		4.5 m		6.0 m		7.5 m				meter
												
6.0 m	Rear blade up (over front)					*5 790	4 900	4 710	3 410	*4 000	3 190	7.79
	Rear blade down (over rear)					*5 790	5 400	*5 010	3 770	*4 000	3 530	
	Rear outrigger down (over rear)					*5 790	*5 790	*5 010	4 380	*4 000	*4 000	
	Front outrigger and rear blade down (over rear)					*5 790	*5 790	*5 010	*5 010	*4 000	*4 000	
	Front blade and rear outrigger down (over rear)					*5 790	*5 790	*5 010	*5 010	*4 000	*4 000	
	4 outrigger down (over rear)					*5 790	*5 790	*5 010	*5 010	*4 000	*4 000	
4.5 m	Rear blade up (over front)			*7 880	7 190	6 520	4 700	4 640	3 340	3 850	2 750	8.43
	Rear blade down (over rear)			*7 880	*7 880	*6 620	5 200	*6 020	3 700	*3 970	3 050	
	Rear outrigger down (over rear)			*7 880	*7 880	*6 620	6 050	*6 020	4 300	*3 970	3 570	
	Front outrigger and rear blade down (over rear)			*7 880	*7 880	*6 620	*6 620	*6 020	5 320	*3 970	*3 970	
	Front blade and rear outrigger down (over rear)			*7 880	*7 880	*6 620	*6 620	*6 020	5 420	*3 970	*3 970	
	4 outrigger down (over rear)			*7 880	*7 880	*6 620	*6 620	*6 020	*6 020	*3 970	*3 970	
3.0 m	Rear blade up (over front)			9 480	6 570	6 230	4 430	4 500	3 210	3 570	2 530	8.76
	Rear blade down (over rear)			*10 520	7 360	*7 780	4 920	*6 550	3 570	*4 100	2 820	
	Rear outrigger down (over rear)			*10 520	8 730	*7 780	5 770	*6 550	4 170	*4 100	3 300	
	Front outrigger and rear blade down (over rear)			*10 520	*10 520	*7 780	7 200	*6 550	5 180	*4 100	*4 100	
	Front blade and rear outrigger down (over rear)			*10 520	*10 520	*7 780	7 350	*6 550	5 280	*4 100	*4 100	
	4 outrigger down (over rear)			*10 520	*10 520	*7 780	*7 780	*6 550	6 090	*4 100	*4 100	
1.5 m	Rear blade up (over front)			8 930	6 070	5 960	4 170	4 370	3 090	3 480	2 450	8.8
	Rear blade down (over rear)			*12 620	6 850	*8 870	4 660	*7 100	3 440	*4 400	2 740	
	Rear outrigger down (over rear)			*12 620	8 190	*8 870	5 500	6 940	4 040	*4 400	3 220	
	Front outrigger and rear blade down (over rear)			*12 620	10 540	*8 870	6 910	*7 100	5 040	*4 400	4 010	
	Front blade and rear outrigger down (over rear)			*12 620	10 800	*8 870	7 060	*7 100	5 140	*4 400	4 090	
	4 outrigger down (over rear)			*12 620	*12 620	*8 870	8 230	*7 100	5 940	*4 400	*4 400	
0 m (Ground)	Rear blade up (over front)			8 690	5 860	5 780	4 010	4 270	2 990	3 570	2 510	8.56
	Rear blade down (over rear)			*13 390	6 620	*9 520	4 490	*7 440	3 340	*4 950	2 800	
	Rear outrigger down (over rear)			*13 390	7 960	*9 520	5 320	6 820	3 940	*4 950	3 300	
	Front outrigger and rear blade down (over rear)			*13 390	10 290	*9 520	6 730	*7 440	4 940	*4 950	4 120	
	Front blade and rear outrigger down (over rear)			*13 390	10 550	*9 520	6 880	*7 440	5 040	*4 950	4 210	
	4 outrigger down (over rear)			*13 390	12 590	*9 520	8 040	*7 440	5 840	*4 950	4 860	
-1.5 m	Rear blade up (over front)	*8 340	*8 340	8 640	5 820	5 720	3 950	4 240	2 960	3 890	2 720	8.03
	Rear blade down (over rear)	*8 340	*8 340	*13 090	6 580	*9 540	4 430	*7 340	3 310	*5 940	3 040	
	Rear outrigger down (over rear)	*8 340	*8 340	*13 090	7 920	*9 540	5 260	6 790	3 910	*5 940	3 590	
	Front outrigger and rear blade down (over rear)	*8 340	*8 340	*13 090	10 250	*9 540	6 660	*7 340	4 900	*5 940	4 490	
	Front blade and rear outrigger down (over rear)	*8 340	*8 340	*13 090	10 500	*9 540	6 810	*7 340	5 010	*5 940	4 580	
	4 outrigger down (over rear)	*8 340	*8 340	*13 090	12 540	*9 540	7 970	*7 340	5 800	*5 940	5 300	
-3.0 m	Rear blade up (over front)	*14 010	10 940	8 740	5 900	5 760	3 990			4 610	3 230	7.12
	Rear blade down (over rear)	*14 010	12 650	*11 850	6 670	*8 740	4 480			*6 850	3 610	
	Rear outrigger down (over rear)	*14 010	*14 010	*11 850	8 010	*8 740	5 310			*6 850	4 250	
	Front outrigger and rear blade down (over rear)	*14 010	*14 010	*11 850	10 340	*8 740	6 710			*6 850	5 330	
	Front blade and rear outrigger down (over rear)	*14 010	*14 010	*11 850	10 600	*8 740	6 860			*6 850	5 440	
	4 outrigger down (over rear)	*14 010	*14 010	*11 850	*11 850	*8 740	8 020			*6 850	6 310	
-4.5 m	Rear blade up (over front)			8 980	6 120					6 510	4 550	5.64
	Rear blade down (over rear)			*9 110	6 900					*6 800	5 080	
	Rear outrigger down (over rear)			*9 110	8 250					*6 800	6 010	
	Front outrigger and rear blade down (over rear)			*9 110	*9 110					*6 800	*6 800	
	Front blade and rear outrigger down (over rear)			*9 110	*9 110					*6 800	*6 800	
	4 outrigger down (over rear)			*9 110	*9 110					*6 800	*6 800	



# MACHINE CAPACITIES

## ZX220W-7

- Notes:
1. Ratings are based on ISO 10567 : 2007.
  2. Machine capacity does not exceed 75% of tipping load with the machine on firm, level ground or 87% full hydraulic capacity.
  3. The load point is the center-line of the bucket pivot mounting pin on the arm.
  4. \*Indicates load limited by hydraulic capacity.
  5. Each value with Rear blade up over the Front-axle side and each value with Rear blade down over the Rear-axle side respectively, and value in optimal position with positioning cylinder.
  6. 0 m = Ground.

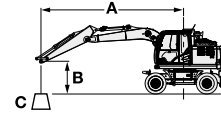

- A: Load radius  
B: Load point height  
C: Machine capacity

For machine capacities, subtract installed attachment and quick hitch weight from machine capacities.

To determine lifting capacities, apply "Rating over-side or 360 degrees" machine capacities from the table and deduct weight of installed attachment and quick hitch.

Optional feature may affect machine performance.

### ZX220W-7 2-PIECE BOOM, ARM 2.41 M, 2 600 KG COUNTERWEIGHT, STANDARD GAUGE

Rating over-front or rear Rating over-side or 360 degrees Unit : kg

Load point height (m)	Stabilization	Load radius										At max. reach			
		1.5 m		3.0 m		4.5 m		6.0 m		7.5 m				meter	
7.5 m	Rear blade up (over front)												*4 960	3 620	5.59
	Rear blade down (over rear)												*4 960	4 080	
	Rear outrigger down (over rear)												*4 960	4 840	
	Front outrigger and rear blade down (over rear)												*4 960	*4 960	
	Front blade and rear outrigger down (over rear)												*4 960	*4 960	
	4 outrigger down (over rear)												*4 960	*4 960	
6.0 m	Rear blade up (over front)							5 330	3 340				4 130	2 520	6.86
	Rear blade down (over rear)							*6 940	3 760				*4 350	2 860	
	Rear outrigger down (over rear)							*6 940	4 440				*4 350	3 410	
	Front outrigger and rear blade down (over rear)							*6 940	*5 640				*4 350	*4 350	
	Front blade and rear outrigger down (over rear)							*6 940	5 760				*4 350	*4 350	
	4 outrigger down (over rear)							*6 940	6 640				*4 350	*4 350	
4.5 m	Rear blade up (over front)					8 170	5 060	5 340	3 350	3 530	2 110	3 420	2 040	7.62	
	Rear blade down (over rear)					*8 800	5 720	*7 420	3 780	*5 200	2 410	*4 140	2 330		
	Rear outrigger down (over rear)					*8 800	6 810	*7 420	4 460	*5 200	2 900	*4 140	2 810		
	Front outrigger and rear blade down (over rear)					*8 800	8 620	*7 420	5 620	*5 200	3 750	*4 140	3 640		
	Front blade and rear outrigger down (over rear)					*8 800	*8 800	*7 420	5 730	*5 200	3 840	*4 140	3 720		
	4 outrigger down (over rear)					*8 800	*8 800	*7 420	6 560	*5 200	4 470	*4 140	*4 140		
3.0 m	Rear blade up (over front)					7 950	4 870	5 290	3 310	3 520	2 110	3 090	1 800	8.01	
	Rear blade down (over rear)					*11 000	5 530	*8 330	3 730	6 690	2 410	*4 150	2 070		
	Rear outrigger down (over rear)					*11 000	6 610	8 260	4 410	5 750	2 890	*4 150	2 510		
	Front outrigger and rear blade down (over rear)					*11 000	8 390	*8 330	5 570	*7 100	3 740	*4 150	3 290		
	Front blade and rear outrigger down (over rear)					*11 000	8 580	*8 330	5 670	6 360	3 830	*4 150	3 360		
	4 outrigger down (over rear)					*11 000	9 930	*8 330	6 480	6 570	4 460	*4 150	3 940		
1.5 m	Rear blade up (over front)			*14 740	8 510	7 860	4 800	5 250	3 260	3 440	2 030	2 970	1 700	8.09	
	Rear blade down (over rear)			*14 740	9 890	*12 820	5 460	*9 220	3 680	6 600	2 330	*4 340	1 970		
	Rear outrigger down (over rear)			*14 740	12 160	*12 820	6 530	8 210	4 360	5 660	2 820	*4 340	2 410		
	Front outrigger and rear blade down (over rear)			*14 740	*14 740	*12 820	8 310	*9 220	5 560	7 450	3 660	*4 340	3 170		
	Front blade and rear outrigger down (over rear)			*14 740	*14 740	*12 820	8 490	8 910	5 690	6 280	3 750	*4 340	3 240		
	4 outrigger down (over rear)			*14 740	*14 740	*12 820	9 820	9 140	6 490	6 490	4 380	*4 340	3 800		
0 m (Ground)	Rear blade up (over front)	*9 060	*9 060	15 040	8 230	7 810	4 660	5 010	3 040	3 330	1 920	3 040	1 730	7.88	
	Rear blade down (over rear)	*9 060	*9 060	*18 270	9 590	*13 420	5 310	9 430	3 460	6 480	2 220	*4 760	2 010		
	Rear outrigger down (over rear)	*9 060	*9 060	*18 270	11 940	13 130	6 370	8 300	4 130	5 540	2 700	*4 760	2 460		
	Front outrigger and rear blade down (over rear)	*9 060	*9 060	*18 270	16 170	*13 420	8 320	*9 700	5 320	7 400	3 540	*4 760	3 240		
	Front blade and rear outrigger down (over rear)	*9 060	*9 060	*18 270	16 680	*13 420	8 530	*8 980	5 450	6 160	3 630	*4 760	3 320		
	4 outrigger down (over rear)	*9 060	*9 060	*18 270	*18 270	*13 420	9 860	9 200	6 350	6 370	4 260	*4 760	3 900		
-1.5 m	Rear blade up (over front)	*16 700	*16 700	14 890	7 880	7 560	4 440	4 720	2 780			3 340	1 900	7.34	
	Rear blade down (over rear)	*16 700	*16 700	*21 750	9 220	*13 580	5 080	9 570	3 190			*5 570	2 210		
	Rear outrigger down (over rear)	*16 700	*16 700	*21 750	11 540	13 390	6 140	8 070	3 850			*5 570	2 700		
	Front outrigger and rear blade down (over rear)	*16 700	*16 700	*21 750	16 120	*13 580	8 060	*9 870	5 030			*5 570	3 570		
	Front blade and rear outrigger down (over rear)	*16 700	*16 700	*21 750	16 670	*13 580	8 270	8 930	5 150			*5 570	3 660		
	4 outrigger down (over rear)	*16 700	*16 700	*21 750	20 640	*13 580	9 830	9 230	6 050			*5 570	4 300		
-3.0 m	Rear blade up (over front)	*29 350	*29 350	14 880	7 880	7 260	4 180	4 540	2 610			4 430	2 550	6.1	
	Rear blade down (over rear)	*29 350	*29 350	*22 510	9 220	*13 880	4 810	*8 520	3 020			*7 960	2 940		
	Rear outrigger down (over rear)	*29 350	*29 350	*22 510	11 540	13 630	5 860	7 870	3 670			7 660	3 590		
	Front outrigger and rear blade down (over rear)	*29 350	*29 350	*22 510	16 110	*13 880	7 760	*8 520	4 840			*7 960	4 730		
	Front blade and rear outrigger down (over rear)	*29 350	*29 350	*22 510	16 660	*13 880	7 960	*8 520	4 960			*7 960	4 840		
	4 outrigger down (over rear)	*29 350	*29 350	*22 510	20 980	*13 880	9 510	*8 520	5 860			*7 960	5 720		

**ZX220W-7 2-PIECE BOOM, ARM 2.41 M, 2 600 KG COUNTERWEIGHT, WIDE GAUGE**

Rating over-front or rear Rating over-side or 360 degrees Unit : kg

Load point height (m)	Stabilization	Load radius										At max. reach		
		1.5 m		3.0 m		4.5 m		6.0 m		7.5 m				meter
7.5 m	Rear blade up (over front)											*4 960	4 050	5.59
	Rear blade down (over rear)											*4 960	4 540	
	Rear outrigger down (over rear)											*4 960	*4 960	
	Front outrigger and rear blade down (over rear)											*4 960	*4 960	
	Front blade and rear outrigger down (over rear)											*4 960	*4 960	
	4 outrigger down (over rear)											*4 960	*4 960	
6.0 m	Rear blade up (over front)							5 360	3 730			4 160	2 830	6.86
	Rear blade down (over rear)							*6 940	4 170			*4 350	3 190	
	Rear outrigger down (over rear)							*6 940	4 930			*4 350	3 810	
	Front outrigger and rear blade down (over rear)							*6 940	6 220			*4 350	*4 350	
	Front blade and rear outrigger down (over rear)							*6 940	6 350			*4 350	*4 350	
	4 outrigger down (over rear)							*6 940	*6 940			*4 350	*4 350	
4.5 m	Rear blade up (over front)					*8 210	5 670	*5 370	3 740	3 550	2 390	3 440	2 310	7.62
	Rear blade down (over rear)					*8 800	6 370	*7 420	4 180	*5 200	2 700	*4 140	2 610	
	Rear outrigger down (over rear)					*8 800	7 590	*7 420	4 950	*5 200	3 240	*4 140	3 140	
	Front outrigger and rear blade down (over rear)					*8 800	*8 800	*7 420	6 160	*5 200	4 160	*4 140	4 040	
	Front blade and rear outrigger down (over rear)					*8 800	*8 800	*7 420	6 280	*5 200	4 250	*4 140	4 130	
	4 outrigger down (over rear)					*8 800	*8 800	*7 420	7 230	*5 200	4 970	*4 140	*4 140	
3.0 m	Rear blade up (over front)					7 980	5 480	*5 310	3 700	3 550	2 390	3 110	2 050	8.01
	Rear blade down (over rear)					*11 000	6 180	*8 330	4 140	6 710	2 700	*4 150	2 340	
	Rear outrigger down (over rear)					*11 000	*7 390	8 270	4 900	5 770	3 240	*4 150	2 830	
	Front outrigger and rear blade down (over rear)					*11 000	9 270	*8 330	*6 090	*7 100	4 150	*4 150	3 660	
	Front blade and rear outrigger down (over rear)					*11 000	9 460	*8 330	6 210	6 400	4 250	*4 150	3 740	
	4 outrigger down (over rear)					*11 000	*11 000	*8 330	7 130	6 620	4 960	*4 150	*4 150	
1.5 m	Rear blade up (over front)			*14 740	9 770	7 900	5 400	5 280	3 650	3 470	2 310	2 990	1 950	8.09
	Rear blade down (over rear)			*14 740	11 310	*12 820	6 100	*9 220	4 090	6 630	2 620	*4 340	2 230	
	Rear outrigger down (over rear)			*14 740	13 780	*12 820	7 300	8 220	4 850	5 680	3 160	*4 340	2 710	
	Front outrigger and rear blade down (over rear)			*14 740	*14 740	*12 820	9 180	*9 220	6 090	*7 470	4 070	*4 340	3 530	
	Front blade and rear outrigger down (over rear)			*14 740	*14 740	*12 820	9 370	8 940	6 220	6 320	4 160	*4 340	3 610	
	4 outrigger down (over rear)			*14 740	*14 740	*12 820	10 920	*9 200	7 120	6 540	4 880	*4 340	4 250	
0 m (Ground)	Rear blade up (over front)	*9 060	*9 060	15 090	9 470	7 850	5 260	5 040	3 430	3 350	2 200	3 060	1 990	7.88
	Rear blade down (over rear)	*9 060	*9 060	*18 270	10 990	*13 420	5 950	9 450	3 860	6 500	2 510	*4 760	2 280	
	Rear outrigger down (over rear)	*9 060	*9 060	*18 270	13 820	13 160	7 170	8 320	4 620	5 550	3 040	*4 760	2 770	
	Front outrigger and rear blade down (over rear)	*9 060	*9 060	*18 270	*18 270	*13 420	9 150	*9 700	5 910	7 450	3 950	*4 760	3 620	
	Front blade and rear outrigger down (over rear)	*9 060	*9 060	*18 270	*18 270	*13 420	9 370	9 020	6 030	6 190	4 040	*4 760	3 700	
	4 outrigger down (over rear)	*9 060	*9 060	*18 270	*18 270	*13 420	11 010	*9 250	7 080	6 430	4 760	*4 760	4 370	
-1.5 m	Rear blade up (over front)	*16 700	*16 700	14 970	9 110	7 600	5 030	4 750	3 160			3 370	2 190	7.34
	Rear blade down (over rear)	*16 700	*16 700	*21 750	10 600	*13 580	5 710	9 600	3 580			*5 570	2 500	
	Rear outrigger down (over rear)	*16 700	*16 700	*21 750	13 400	*13 400	6 920	8 090	4 330			*5 570	3 050	
	Front outrigger and rear blade down (over rear)	*16 700	*16 700	*21 750	18 810	*13 580	9 060	*9 870	5 610			*5 570	3 990	
	Front blade and rear outrigger down (over rear)	*16 700	*16 700	*21 750	19 480	*13 580	9 300	8 980	5 740			*5 570	4 080	
	4 outrigger down (over rear)	*16 700	*16 700	*21 750	*21 750	*13 580	11 160	9 310	6 790			*5 570	4 820	
-3.0 m	Rear blade up (over front)	*29 350	*29 350	14 960	9 100	7 310	4 760	4 570	2 990			4 460	2 920	6.1
	Rear blade down (over rear)	*29 350	*29 350	*22 510	10 600	*13 880	5 430	*8 520	3 410			*7 960	3 330	
	Rear outrigger down (over rear)	*29 350	*29 350	*22 510	13 390	13 670	6 630	7 900	4 150			7 680	4 050	
	Front outrigger and rear blade down (over rear)	*29 350	*29 350	*22 510	18 800	*13 880	8 750	*8 520	5 420			*7 960	5 290	
	Front blade and rear outrigger down (over rear)	*29 350	*29 350	*22 510	19 470	*13 880	8 980	*8 520	5 550			*7 960	5 420	
	4 outrigger down (over rear)	*29 350	*29 350	*22 510	*22 510	*13 880	10 820	*8 520	6 600			*7 960	6 430	



# MACHINE CAPACITIES

## ZX220W-7

- Notes:
1. Ratings are based on ISO 10567 : 2007.
  2. Machine capacity does not exceed 75% of tipping load with the machine on firm, level ground or 87% full hydraulic capacity.
  3. The load point is the center-line of the bucket pivot mounting pin on the arm.
  4. \*Indicates load limited by hydraulic capacity.
  5. Each value with Rear blade up over the Front-axle side and each value with Rear blade down over the Rear-axle side respectively, and value in optimal position with positioning cylinder.
  6. 0 m = Ground.

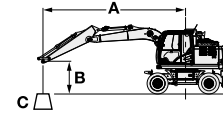

- A: Load radius  
B: Load point height  
C: Machine capacity

For machine capacities, subtract installed attachment and quick hitch weight from machine capacities.

To determine lifting capacities, apply "Rating over-side or 360 degrees" machine capacities from the table and deduct weight of installed attachment and quick hitch.

Optional feature may affect machine performance.













### ZX220W-7 2-PIECE BOOM, ARM 2.41 M, 4 300 KG COUNTERWEIGHT, STANDARD GAUGE

Rating over-front or rear Rating over-side or 360 degrees Unit : kg

Load point height (m)	Stabilization	Load radius										At max. reach		meter
		1.5 m		3.0 m		4.5 m		6.0 m		7.5 m				
7.5 m	Rear blade up (over front)											*4 960	4 590	5.59
	Rear blade down (over rear)											*4 960	*4 960	
	Rear outrigger down (over rear)											*4 960	*4 960	
	Front outrigger and rear blade down (over rear)											*4 960	*4 960	
	Front blade and rear outrigger down (over rear)											*4 960	*4 960	
	4 outrigger down (over rear)											*4 960	*4 960	
6.0 m	Rear blade up (over front)							6 390	4 230			*4 350	3 280	6.86
	Rear blade down (over rear)							*6 940	4 700			*4 350	3 660	
	Rear outrigger down (over rear)							*6 940	5 450			*4 350	4 270	
	Front outrigger and rear blade down (over rear)							*6 940	6 710			*4 350	*4 350	
	Front blade and rear outrigger down (over rear)							*6 940	6 830			*4 350	*4 350	
	4 outrigger down (over rear)							*6 940	*6 940			*4 350	*4 350	
4.5 m	Rear blade up (over front)					*8 800	6 330	6 330	4 250	4 360	2 800	*4 140	2 710	7.62
	Rear blade down (over rear)					*8 800	7 070	*7 420	4 720	*5 200	3 140	*4 140	3 040	
	Rear outrigger down (over rear)					*8 800	8 190	*7 420	5 450	*5 200	3 670	*4 140	3 560	
	Front outrigger and rear blade down (over rear)					*8 800	*8 800	*7 420	6 630	*5 200	4 600	*4 140	*4 140	
	Front blade and rear outrigger down (over rear)					*8 800	*8 800	*7 420	6 750	*5 200	4 690	*4 140	*4 140	
	4 outrigger down (over rear)					*8 800	*8 800	*7 420	*7 420	*5 200	*5 200	*4 140	*4 140	
3.0 m	Rear blade up (over front)					*9 360	6 140	6 260	4 200	4 350	2 790	3 850	2 440	8.01
	Rear blade down (over rear)					*11 000	6 880	*8 330	4 670	*7 100	3 130	*4 150	2 740	
	Rear outrigger down (over rear)					*11 000	7 980	*8 330	5 400	6 840	3 660	*4 150	3 230	
	Front outrigger and rear blade down (over rear)					*11 000	9 840	*8 330	6 550	*7 100	4 590	*4 150	4 070	
	Front blade and rear outrigger down (over rear)					*11 000	10 040	*8 330	6 670	*7 100	4 680	*4 150	*4 150	
	4 outrigger down (over rear)					*11 000	*11 000	*8 330	7 550	*7 100	5 370	*4 150	*4 150	
1.5 m	Rear blade up (over front)			*14 740	10 720	9 270	6 070	6 270	4 150	4 270	2 720	3 730	2 330	8.09
	Rear blade down (over rear)			*14 740	12 190	*12 820	6 810	*9 220	4 620	*7 470	3 050	*4 340	2 630	
	Rear outrigger down (over rear)			*14 740	14 530	*12 820	7 900	*9 220	5 370	6 770	3 590	*4 340	3 110	
	Front outrigger and rear blade down (over rear)			*14 740	*14 740	*12 820	9 750	*9 220	6 560	*7 470	4 510	*4 340	3 940	
	Front blade and rear outrigger down (over rear)			*14 740	*14 740	*12 820	9 950	*9 220	6 670	7 370	4 600	*4 340	4 020	
	4 outrigger down (over rear)			*14 740	*14 740	*12 820	*11 380	*9 220	7 530	*7 470	5 290	*4 340	*4 340	
0 m (Ground)	Rear blade up (over front)	*9 060	*9 060	17 900	10 430	*9 270	5 930	6 100	3 940	4 160	2 610	3 820	2 380	7.88
	Rear blade down (over rear)	*9 060	*9 060	*18 270	11 990	*13 420	6 660	*9 700	4 400	*7 630	2 940	*4 760	2 690	
	Rear outrigger down (over rear)	*9 060	*9 060	*18 270	14 670	*13 420	7 850	*9 470	5 140	6 650	3 470	*4 760	3 180	
	Front outrigger and rear blade down (over rear)	*9 060	*9 060	*18 270	*18 270	*13 420	9 780	*9 700	6 430	*7 630	4 390	*4 760	4 040	
	Front blade and rear outrigger down (over rear)	*9 060	*9 060	*18 270	*18 270	*13 420	*9 990	*9 700	6 560	7 270	4 480	*4 760	4 130	
	4 outrigger down (over rear)	*9 060	*9 060	*18 270	*18 270	*13 420	*11 470	*9 700	7 540	7 480	5 170	*4 760	*4 760	
-1.5 m	Rear blade up (over front)	*16 700	*16 700	18 050	10 090	9 190	5 710	5 820	3 670			4 200	2 610	7.34
	Rear blade down (over rear)	*16 700	*16 700	*21 750	11 630	*13 580	6 430	*9 870	4 130			*5 570	2 950	
	Rear outrigger down (over rear)	*16 700	*16 700	*21 750	14 270	*13 580	7 620	9 620	4 860			*5 570	3 490	
	Front outrigger and rear blade down (over rear)	*16 700	*16 700	*21 750	19 430	*13 580	9 740	*9 870	6 150			*5 570	4 440	
	Front blade and rear outrigger down (over rear)	*16 700	*16 700	*21 750	19 920	*13 580	9 980	*9 870	6 290			*5 570	4 540	
	4 outrigger down (over rear)	*16 700	*16 700	*21 750	*21 750	*13 580	11 720	*9 870	7 280			*5 570	5 250	
-3.0 m	Rear blade up (over front)	*29 350	*29 350	18 040	10 080	8 900	5 450	5 640	3 500			5 510	3 420	6.1
	Rear blade down (over rear)	*29 350	*29 350	*22 510	11 620	*13 880	6 160	*8 520	3 960			*7 960	3 870	
	Rear outrigger down (over rear)	*29 350	*29 350	*22 510	14 270	*13 880	7 330	*8 520	4 690			*7 960	4 580	
	Front outrigger and rear blade down (over rear)	*29 350	*29 350	*22 510	19 420	*13 880	9 440	*8 520	5 970			*7 960	5 830	
	Front blade and rear outrigger down (over rear)	*29 350	*29 350	*22 510	20 050	*13 880	9 670	*8 520	6 100			*7 960	5 960	
	4 outrigger down (over rear)	*29 350	*29 350	*22 510	*22 510	*13 880	11 390	*8 520	7 100			*7 960	6 930	

**ZX220W-7 2-PIECE BOOM, ARM 2.41 M, 4 300 KG COUNTERWEIGHT, WIDE GAUGE**

 Rating over-front or rear  Rating over-side or 360 degrees Unit : kg

Load point height (m)	Stabilization	Load radius										At max. reach		
		1.5 m		3.0 m		4.5 m		6.0 m		7.5 m				meter
														
7.5 m	Rear blade up (over front)											*4 960	*4 960	5.59
	Rear blade down (over rear)											*4 960	*4 960	
	Rear outrigger down (over rear)											*4 960	*4 960	
	Front outrigger and rear blade down (over rear)											*4 960	*4 960	
	Front blade and rear outrigger down (over rear)											*4 960	*4 960	
	4 outrigger down (over rear)											*4 960	*4 960	
6.0 m	Rear blade up (over front)							6 420	4 660			*4 350	3 630	6.86
	Rear blade down (over rear)							*6 940	5 150			*4 350	4 030	
	Rear outrigger down (over rear)							*6 940	5 990			*4 350	*4 350	
	Front outrigger and rear blade down (over rear)							*6 940	*6 940			*4 350	*4 350	
	Front blade and rear outrigger down (over rear)							*6 940	*6 940			*4 350	*4 350	
	4 outrigger down (over rear)							*6 940	*6 940			*4 350	*4 350	
4.5 m	Rear blade up (over front)					*8 800	7 010	6 350	4 680	4 380	3 110	*4 140	3 020	7.62
	Rear blade down (over rear)					*8 800	*7 760	*7 420	5 170	*5 200	3 460	*4 140	3 350	
	Rear outrigger down (over rear)					*8 800	*8 800	*7 420	5 940	*5 200	4 050	*4 140	3 940	
	Front outrigger and rear blade down (over rear)					*8 800	*8 800	*7 420	7 220	*5 200	5 040	*4 140	*4 140	
	Front blade and rear outrigger down (over rear)					*8 800	*8 800	*7 420	7 350	*5 200	5 140	*4 140	*4 140	
	4 outrigger down (over rear)					*8 800	*8 800	*7 420	*7 420	*5 200	*5 200	*4 140	*4 140	
3.0 m	Rear blade up (over front)					9 400	6 820	6 290	4 630	4 370	3 100	3 870	2 720	8.01
	Rear blade down (over rear)					*11 000	*7 560	*8 330	5 130	*7 100	3 450	*4 150	3 030	
	Rear outrigger down (over rear)					*11 000	*8 760	*8 330	5 880	6 860	4 050	*4 150	3 570	
	Front outrigger and rear blade down (over rear)					*11 000	10 790	*8 330	7 120	*7 100	5 030	*4 150	*4 150	
	Front blade and rear outrigger down (over rear)					*11 000	*11 000	*8 330	7 260	*7 100	5 130	*4 150	*4 150	
	4 outrigger down (over rear)					*11 000	*11 000	*8 330	8 250	*7 100	5 910	*4 150	*4 150	
1.5 m	Rear blade up (over front)			*14 740	*12 070	9 320	6 750	6 300	4 580	4 300	3 030	3 750	2 610	8.09
	Rear blade down (over rear)			*14 740	13 590	*12 820	7 480	*9 220	5 070	*7 470	3 370	*4 340	2 920	
	Rear outrigger down (over rear)			*14 740	*14 740	*12 820	*8 680	*9 220	5 870	6 790	3 970	*4 340	3 450	
	Front outrigger and rear blade down (over rear)			*14 740	*14 740	*12 820	10 690	*9 220	7 110	*7 470	4 950	*4 340	4 340	
	Front blade and rear outrigger down (over rear)			*14 740	*14 740	*12 820	*10 900	*9 220	7 240	*7 390	5 050	*4 340	*4 340	
	4 outrigger down (over rear)			*14 740	*14 740	*12 820	12 550	*9 220	8 210	*7 470	5 830	*4 340	*4 340	
0 m (Ground)	Rear blade up (over front)	*9 060	*9 060	*17 970	11 850	9 300	6 600	6 130	4 360	4 180	2 920	3 840	2 670	7.88
	Rear blade down (over rear)	*9 060	*9 060	*18 270	13 590	*13 420	7 380	*9 700	4 850	*7 630	3 260	*4 760	2 990	
	Rear outrigger down (over rear)	*9 060	*9 060	*18 270	16 450	*13 420	8 750	9 490	5 680	6 660	3 850	*4 760	3 540	
	Front outrigger and rear blade down (over rear)	*9 060	*9 060	*18 270	*18 270	*13 420	10 780	*9 700	7 070	*7 630	4 840	*4 760	4 450	
	Front blade and rear outrigger down (over rear)	*9 060	*9 060	*18 270	*18 270	*13 420	10 980	*9 700	7 210	7 300	4 940	*4 760	4 550	
	4 outrigger down (over rear)	*9 060	*9 060	*18 270	*18 270	*13 420	12 620	*9 700	8 290	7 530	5 720	*4 760	*4 760	
-1.5 m	Rear blade up (over front)	*16 700	*16 700	18 130	11 490	9 240	6 370	5 850	4 090			4 220	2 920	7.34
	Rear blade down (over rear)	*16 700	*16 700	*21 750	13 210	*13 580	7 140	*9 870	4 570			*5 570	3 280	
	Rear outrigger down (over rear)	*16 700	*16 700	*21 750	16 400	*13 580	8 500	9 640	5 400			*5 570	3 880	
	Front outrigger and rear blade down (over rear)	*16 700	*16 700	*21 750	21 660	*13 580	10 860	*9 870	6 800			*5 570	4 900	
	Front blade and rear outrigger down (over rear)	*16 700	*16 700	*21 750	*21 750	*13 580	11 120	*9 870	6 950			*5 570	5 000	
	4 outrigger down (over rear)	*16 700	*16 700	*21 750	*21 750	*13 580	*12 890	*9 870	8 080			*5 570	*5 570	
-3.0 m	Rear blade up (over front)	*29 350	*29 350	18 120	11 480	8 940	6 100	5 670	3 920			5 540	3 830	6.1
	Rear blade down (over rear)	*29 350	*29 350	*22 510	13 210	*13 880	6 870	*8 520	4 400			*7 960	4 300	
	Rear outrigger down (over rear)	*29 350	*29 350	*22 510	16 390	*13 880	8 210	*8 520	5 220			*7 960	5 100	
	Front outrigger and rear blade down (over rear)	*29 350	*29 350	*22 510	22 480	*13 880	10 550	*8 520	6 610			*7 960	6 450	
	Front blade and rear outrigger down (over rear)	*29 350	*29 350	*22 510	*22 510	*13 880	10 810	*8 520	6 760			*7 960	6 600	
	4 outrigger down (over rear)	*29 350	*29 350	*22 510	*22 510	*13 880	12 850	*8 520	7 910			*7 960	7 710	



# MACHINE CAPACITIES

## ZX220W-7

- Notes:
1. Ratings are based on ISO 10567 : 2007.
  2. Machine capacity does not exceed 75% of tipping load with the machine on firm, level ground or 87% full hydraulic capacity.
  3. The load point is the center-line of the bucket pivot mounting pin on the arm.
  4. \*Indicates load limited by hydraulic capacity.
  5. Each value with Rear blade up over the Front-axle side and each value with Rear blade down over the Rear-axle side respectively, and value in optimal position with positioning cylinder.
  6. 0 m = Ground.

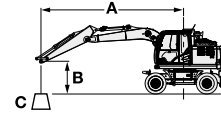

- A: Load radius  
B: Load point height  
C: Machine capacity

For machine capacities, subtract installed attachment and quick hitch weight from machine capacities.

To determine lifting capacities, apply "Rating over-side or 360 degrees" machine capacities from the table and deduct weight of installed attachment and quick hitch.

Optional feature may affect machine performance.













### ZX220W-7 2-PIECE BOOM, ARM 2.41 M, 5 000 KG COUNTERWEIGHT, STANDARD GAUGE

Rating over-front or rear Rating over-side or 360 degrees Unit : kg

Load point height (m)	Stabilization	Load radius										At max. reach		meter		
		1.5 m		3.0 m		4.5 m		6.0 m		7.5 m						
7.5 m	Rear blade up (over front)													*4 960	*4 960	5.59
	Rear blade down (over rear)													*4 960	*4 960	
	Rear outrigger down (over rear)													*4 960	*4 960	
	Front outrigger and rear blade down (over rear)													*4 960	*4 960	
	Front blade and rear outrigger down (over rear)													*4 960	*4 960	
	4 outrigger down (over rear)													*4 960	*4 960	
6.0 m	Rear blade up (over front)							6 810	4 600					*4 350	3 590	6.86
	Rear blade down (over rear)							*6 940	5 090					*4 350	3 990	
	Rear outrigger down (over rear)							*6 940	5 860					*4 350	*4 350	
	Front outrigger and rear blade down (over rear)							*6 940	*6 940					*4 350	*4 350	
	Front blade and rear outrigger down (over rear)							*6 940	*6 940					*4 350	*4 350	
	4 outrigger down (over rear)							*6 940	*6 940					*4 350	*4 350	
4.5 m	Rear blade up (over front)					*8 800	6 850	6 740	4 610	4 700	3 080			*4 140	2 990	7.62
	Rear blade down (over rear)					*8 800	*7 600	*7 420	5 100	*5 200	3 430			*4 140	3 330	
	Rear outrigger down (over rear)					*8 800	8 730	*7 420	5 830	*5 200	3 990			*4 140	3 880	
	Front outrigger and rear blade down (over rear)					*8 800	*8 800	*7 420	7 050	*5 200	4 940			*4 140	*4 140	
	Front blade and rear outrigger down (over rear)					*8 800	*8 800	*7 420	7 170	*5 200	5 040			*4 140	*4 140	
	4 outrigger down (over rear)					*8 800	*8 800	*7 420	*7 420	*5 200	*5 200			*4 140	*4 140	
3.0 m	Rear blade up (over front)					9 940	6 670	6 660	4 570	4 690	3 080			*4 150	2 700	8.01
	Rear blade down (over rear)					*11 000	7 410	*8 330	5 060	*7 100	3 430			*4 150	3 020	
	Rear outrigger down (over rear)					*11 000	8 520	*8 330	5 770	*7 100	3 980			*4 150	3 520	
	Front outrigger and rear blade down (over rear)					*11 000	10 430	*8 330	6 960	*7 100	4 930			*4 150	*4 150	
	Front blade and rear outrigger down (over rear)					*11 000	10 640	*8 330	7 080	*7 100	5 030			*4 150	*4 150	
	4 outrigger down (over rear)					*11 000	*11 000	*8 330	7 980	*7 100	5 740			*4 150	*4 150	
1.5 m	Rear blade up (over front)			*14 740	11 590	9 860	6 600	6 660	4 520	4 610	3 000			4 040	2 590	8.09
	Rear blade down (over rear)			*14 740	13 050	*12 820	7 340	*9 220	5 010	*7 470	3 350			*4 340	2 910	
	Rear outrigger down (over rear)			*14 740	*14 740	*12 820	8 430	*9 220	5 790	7 220	3 900			*4 340	3 400	
	Front outrigger and rear blade down (over rear)			*14 740	*14 740	*12 820	10 340	*9 220	6 950	*7 470	4 850			*4 340	4 260	
	Front blade and rear outrigger down (over rear)			*14 740	*14 740	*12 820	10 540	*9 220	7 070	*7 470	4 950			*4 340	*4 340	
	4 outrigger down (over rear)			*14 740	*14 740	*12 820	12 020	*9 220	7 950	*7 470	5 660			*4 340	*4 340	
0 m (Ground)	Rear blade up (over front)	*9 060	*9 060	*18 270	11 330	9 890	6 450	6 550	4 300	4 500	2 890			4 140	2 650	7.88
	Rear blade down (over rear)	*9 060	*9 060	*18 270	12 980	*13 420	7 220	*9 700	4 790	*7 630	3 240			*4 760	2 970	
	Rear outrigger down (over rear)	*9 060	*9 060	*18 270	15 510	*13 420	8 460	*9 700	5 560	7 110	3 790			*4 760	3 480	
	Front outrigger and rear blade down (over rear)	*9 060	*9 060	*18 270	*18 270	*13 420	10 420	*9 700	6 880	*7 630	4 740			*4 760	4 370	
	Front blade and rear outrigger down (over rear)	*9 060	*9 060	*18 270	*18 270	*13 420	10 630	*9 700	7 030	*7 630	4 840			*4 760	4 460	
	4 outrigger down (over rear)	*9 060	*9 060	*18 270	*18 270	*13 420	12 100	*9 700	8 010	*7 630	*5 540			*4 760	*4 760	
-1.5 m	Rear blade up (over front)	*16 700	*16 700	19 350	10 990	9 870	6 230	6 280	4 040					4 550	2 900	7.34
	Rear blade down (over rear)	*16 700	*16 700	*21 750	12 620	*13 580	6 990	*9 870	4 520					*5 570	3 250	
	Rear outrigger down (over rear)	*16 700	*16 700	*21 750	15 400	*13 580	8 220	*9 870	5 280					*5 570	3 820	
	Front outrigger and rear blade down (over rear)	*16 700	*16 700	*21 750	20 510	*13 580	10 440	*9 870	6 620					*5 570	4 800	
	Front blade and rear outrigger down (over rear)	*16 700	*16 700	*21 750	21 000	*13 580	10 680	*9 870	6 760					*5 570	4 900	
	4 outrigger down (over rear)	*16 700	*16 700	*21 750	*21 750	*13 580	*12 300	*9 870	7 780					*5 570	*5 570	
-3.0 m	Rear blade up (over front)	*29 350	*29 350	19 340	10 980	9 570	5 970	6 090	3 870					5 950	3 780	6.1
	Rear blade down (over rear)	*29 350	*29 350	*22 510	12 610	*13 880	6 720	*8 520	4 350					*7 960	4 250	
	Rear outrigger down (over rear)	*29 350	*29 350	*22 510	15 390	*13 880	7 940	*8 520	5 110					*7 960	4 990	
	Front outrigger and rear blade down (over rear)	*29 350	*29 350	*22 510	20 780	*13 880	10 130	*8 520	6 440					*7 960	6 290	
	Front blade and rear outrigger down (over rear)	*29 350	*29 350	*22 510	21 440	*13 880	10 370	*8 520	6 570					*7 960	6 420	
	4 outrigger down (over rear)	*29 350	*29 350	*22 510	*22 510	*13 880	12 170	*8 520	7 600					*7 960	7 420	

**ZX220W-7 2-PIECE BOOM, ARM 2.41 M, 5 000 KG COUNTERWEIGHT, WIDE GAUGE**

 Rating over-front or rear    Rating over-side or 360 degrees   Unit : kg

Load point height (m)	Stabilization	Load radius										At max. reach		
		1.5 m		3.0 m		4.5 m		6.0 m		7.5 m				meter
														
7.5 m	Rear blade up (over front)											*4 960	*4 960	5.59
	Rear blade down (over rear)											*4 960	*4 960	
	Rear outrigger down (over rear)											*4 960	*4 960	
	Front outrigger and rear blade down (over rear)											*4 960	*4 960	
	Front blade and rear outrigger down (over rear)											*4 960	*4 960	
	4 outrigger down (over rear)											*4 960	*4 960	
6.0 m	Rear blade up (over front)							6 840	5 050			*4 350	3 960	6.86
	Rear blade down (over rear)							*6 940	5 560			*4 350	*4 350	
	Rear outrigger down (over rear)							*6 940	6 400			*4 350	*4 350	
	Front outrigger and rear blade down (over rear)							*6 940	*6 940			*4 350	*4 350	
	Front blade and rear outrigger down (over rear)							*6 940	*6 940			*4 350	*4 350	
	4 outrigger down (over rear)							*6 940	*6 940			*4 350	*4 350	
4.5 m	Rear blade up (over front)					*8 800	7 540	6 760	5 060	4 720	3 410	*4 140	3 310	7.62
	Rear blade down (over rear)					*8 800	*8 280	*7 420	5 540	*5 200	3 770	*4 140	3 660	
	Rear outrigger down (over rear)					*8 800	*8 800	*7 420	6 340	*5 200	4 380	*4 140	*4 140	
	Front outrigger and rear blade down (over rear)					*8 800	*8 800	*7 420	*7 420	*5 200	*5 200	*4 140	*4 140	
	Front blade and rear outrigger down (over rear)					*8 800	*8 800	*7 420	*7 420	*5 200	*5 200	*4 140	*4 140	
	4 outrigger down (over rear)					*8 800	*8 800	*7 420	*7 420	*5 200	*5 200	*4 140	*4 140	
3.0 m	Rear blade up (over front)					9 980	7 350	6 680	5 020	4 710	3 400	*4 150	2 990	8.01
	Rear blade down (over rear)					*11 000	8 080	*8 330	5 490	*7 100	3 760	*4 150	3 320	
	Rear outrigger down (over rear)					*11 000	9 320	*8 330	6 270	*7 100	4 380	*4 150	3 880	
	Front outrigger and rear blade down (over rear)					*11 000	*11 000	*8 330	7 550	*7 100	5 390	*4 150	*4 150	
	Front blade and rear outrigger down (over rear)					*11 000	*11 000	*8 330	7 690	*7 100	5 500	*4 150	*4 150	
	4 outrigger down (over rear)					*11 000	*11 000	*8 330	*8 330	*7 100	6 300	*4 150	*4 150	
1.5 m	Rear blade up (over front)			*14 740	12 930	9 880	7 270	6 680	4 970	4 630	3 320	4 060	2 880	8.09
	Rear blade down (over rear)			*14 740	14 530	*12 820	8 000	*9 220	5 480	*7 470	3 680	*4 340	3 210	
	Rear outrigger down (over rear)			*14 740	*14 740	*12 820	9 240	*9 220	6 280	7 240	4 300	*4 340	3 760	
	Front outrigger and rear blade down (over rear)			*14 740	*14 740	*12 820	11 300	*9 220	7 520	*7 470	5 310	*4 340	*4 340	
	Front blade and rear outrigger down (over rear)			*14 740	*14 740	*12 820	11 520	*9 220	7 650	*7 470	5 420	*4 340	*4 340	
	4 outrigger down (over rear)			*14 740	*14 740	*12 820	*12 820	*9 220	8 650	*7 470	6 230	*4 340	*4 340	
0 m (Ground)	Rear blade up (over front)	*9 060	*9 060	*18 270	12 830	9 930	7 150	6 570	4 750	4 520	3 210	4 160	2 950	7.88
	Rear blade down (over rear)	*9 060	*9 060	*18 270	14 670	*13 420	7 970	*9 700	5 260	*7 630	3 570	*4 760	3 280	
	Rear outrigger down (over rear)	*9 060	*9 060	*18 270	17 550	*13 420	9 230	*9 700	6 110	7 120	4 180	*4 760	3 850	
	Front outrigger and rear blade down (over rear)	*9 060	*9 060	*18 270	*18 270	*13 420	11 380	*9 700	7 540	*7 630	5 200	*4 760	*4 760	
	Front blade and rear outrigger down (over rear)	*9 060	*9 060	*18 270	*18 270	*13 420	11 600	*9 700	7 680	*7 630	5 300	*4 760	*4 760	
	4 outrigger down (over rear)	*9 060	*9 060	*18 270	*18 270	*13 420	13 220	*9 700	8 730	*7 630	6 110	*4 760	*4 760	
-1.5 m	Rear blade up (over front)	*16 700	*16 700	19 440	12 470	9 910	6 930	6 300	4 480			4 570	3 230	7.34
	Rear blade down (over rear)	*16 700	*16 700	*21 750	14 290	*13 580	7 730	*9 870	4 980			*5 570	3 600	
	Rear outrigger down (over rear)	*16 700	*16 700	*21 750	17 630	*13 580	9 150	*9 870	5 840			*5 570	4 220	
	Front outrigger and rear blade down (over rear)	*16 700	*16 700	*21 750	*21 750	*13 580	11 600	*9 870	7 280			*5 570	5 280	
	Front blade and rear outrigger down (over rear)	*16 700	*16 700	*21 750	*21 750	*13 580	11 870	*9 870	7 440			*5 570	5 380	
	4 outrigger down (over rear)	*16 700	*16 700	*21 750	*21 750	*13 580	13 440	*9 870	8 610			*5 570	*5 570	
-3.0 m	Rear blade up (over front)	*29 350	*29 350	19 430	12 460	9 610	6 660	6 120	4 310			5 980	4 210	6.1
	Rear blade down (over rear)	*29 350	*29 350	*22 510	14 280	*13 880	7 460	*8 520	4 800			*7 960	4 690	
	Rear outrigger down (over rear)	*29 350	*29 350	*22 510	17 630	*13 880	8 860	*8 520	5 660			*7 960	5 530	
	Front outrigger and rear blade down (over rear)	*29 350	*29 350	*22 510	*22 510	*13 880	11 290	*8 520	7 100			*7 960	6 930	
	Front blade and rear outrigger down (over rear)	*29 350	*29 350	*22 510	*22 510	*13 880	11 560	*8 520	7 250			*7 960	7 080	
	4 outrigger down (over rear)	*29 350	*29 350	*22 510	*22 510	*13 880	13 690	*8 520	8 450			*7 960	*7 960	



# MACHINE CAPACITIES

## ZX220W-7

- Notes:
1. Ratings are based on ISO 10567 : 2007.
  2. Machine capacity does not exceed 75% of tipping load with the machine on firm, level ground or 87% full hydraulic capacity.
  3. The load point is the center-line of the bucket pivot mounting pin on the arm.
  4. \*Indicates load limited by hydraulic capacity.
  5. Each value with Rear blade up over the Front-axle side and each value with Rear blade down over the Rear-axle side respectively, and value in optimal position with positioning cylinder.
  6. 0 m = Ground.

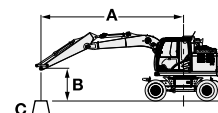

- A: Load radius  
B: Load point height  
C: Machine capacity

For machine capacities, subtract installed attachment and quick hitch weight from machine capacities.

To determine lifting capacities, apply "Rating over-side or 360 degrees" machine capacities from the table and deduct weight of installed attachment and quick hitch.

Optional feature may affect machine performance.

### ZX220W-7 2-PIECE BOOM, ARM 2.61 M, 2 600 KG COUNTERWEIGHT, STANDARD GAUGE

Rating over-front or rear Rating over-side or 360 degrees Unit : kg

Load point height (m)	Stabilization	Load radius										At max. reach		meter		
		1.5 m		3.0 m		4.5 m		6.0 m		7.5 m						
7.5 m	Rear blade up (over front)												*4 480	3 340	5.87	
	Rear blade down (over rear)												*4 480	3 770		
	Rear outrigger down (over rear)												*4 480	4 470		
	Front outrigger and rear blade down (over rear)												*4 480	*4 480		
	Front blade and rear outrigger down (over rear)												*4 480	*4 480		
4 outrigger down (over rear)												*4 480	*4 480			
6.0 m	Rear blade up (over front)							5 380	3 380				3 920	2 370	7.09	
	Rear blade down (over rear)							*6 670	3 800				*3 960	2 700		
	Rear outrigger down (over rear)							*6 670	4 490				*3 960	3 230		
	Front outrigger and rear blade down (over rear)							*6 670	5 670				*3 960	*3 960		
	Front blade and rear outrigger down (over rear)							*6 670	5 790				*3 960	*3 960		
4 outrigger down (over rear)							*6 670	6 640				*3 960	*3 960			
4.5 m	Rear blade up (over front)					8 180	5 060	5 330	3 340	3 570	2 150	3 270	1 940	7.82		
	Rear blade down (over rear)					*8 440	5 730	*7 200	3 770	*5 750	2 450	*3 780	2 220			
	Rear outrigger down (over rear)					*8 440	6 820	*7 200	4 450	*5 750	2 940	*3 780	2 680			
	Front outrigger and rear blade down (over rear)					*8 440	*8 440	*7 200	5 610	*5 750	3 790	*3 780	3 480			
	Front blade and rear outrigger down (over rear)					*8 440	*8 440	*7 200	5 720	*5 750	3 870	*3 780	3 560			
4 outrigger down (over rear)					*8 440	*8 440	*7 200	6 550	*5 750	4 510	*3 780	*3 780				
3.0 m	Rear blade up (over front)					7 940	4 860	*5 260	3 290	3 560	2 140	2 960	1 710	8.2		
	Rear blade down (over rear)					*10 650	5 520	*8 130	3 710	*6 710	2 440	*3 780	1 980			
	Rear outrigger down (over rear)					*10 650	6 600	*8 130	4 390	5 770	2 920	*3 780	2 410			
	Front outrigger and rear blade down (over rear)					*10 650	8 380	*8 130	*5 540	*6 960	3 780	*3 780	3 150			
	Front blade and rear outrigger down (over rear)					*10 650	8 570	*8 130	5 650	6 380	3 860	*3 780	3 230			
4 outrigger down (over rear)					*10 650	9 910	*8 130	6 460	6 590	4 490	*3 780	3 780				
1.5 m	Rear blade up (over front)					*14 600	8 450	7 830	4 760	5 270	3 270	3 470	2 060	2 850	1 620	8.28
	Rear blade down (over rear)					*14 600	9 830	*12 580	5 410	*9 070	3 690	6 620	2 360	*3 950	1 880	
	Rear outrigger down (over rear)					*14 600	12 100	*12 580	6 490	8 170	4 370	5 690	2 840	*3 950	2 300	
	Front outrigger and rear blade down (over rear)					*14 600	*14 600	*12 580	8 270	*9 070	5 530	*7 360	3 690	*3 950	3 040	
	Front blade and rear outrigger down (over rear)					*14 600	*14 600	*12 580	8 450	*8 870	5 650	6 300	3 780	*3 950	3 110	
4 outrigger down (over rear)					*14 600	*14 600	*12 580	9 780	*9 070	6 440	6 510	4 410	*3 950	3 660		
0 m (Ground)	Rear blade up (over front)	*8 830	*8 830	15 010	8 260	7 820	4 660	5 070	3 090	3 340	1 940	2 910	1 640	8.08		
	Rear blade down (over rear)	*8 830	*8 830	*17 810	9 620	*13 340	5 310	*9 380	3 500	6 490	2 230	*4 310	1 910			
	Rear outrigger down (over rear)	*8 830	*8 830	*17 810	11 980	13 060	6 380	8 250	4 180	5 550	2 720	*4 310	2 350			
	Front outrigger and rear blade down (over rear)	*8 830	*8 830	*17 810	16 130	*13 340	8 330	*9 620	5 370	7 410	3 560	*4 310	3 110			
	Front blade and rear outrigger down (over rear)	*8 830	*8 830	*17 810	16 640	*13 340	*8 460	8 920	5 490	6 170	3 650	*4 310	3 180			
4 outrigger down (over rear)	*8 830	*8 830	*17 810	*17 810	*13 340	9 840	9 140	6 360	6 380	4 280	*4 310	3 740				
-1.5 m	Rear blade up (over front)	*15 570	*15 570	14 870	7 860	7 550	4 420	4 760	2 800	3 220	1 820	3 180	1 800	7.56		
	Rear blade down (over rear)	*15 570	*15 570	*21 380	9 200	*13 490	5 060	9 590	3 210	*5 910	2 120	*5 000	2 090			
	Rear outrigger down (over rear)	*15 570	*15 570	*21 380	11 520	*13 290	6 120	8 090	3 880	5 420	2 600	*5 000	2 570			
	Front outrigger and rear blade down (over rear)	*15 570	*15 570	*21 380	16 100	*13 490	8 050	*9 780	5 060	*5 910	3 440	*5 000	3 400			
	Front blade and rear outrigger down (over rear)	*15 570	*15 570	*21 380	16 650	*13 490	8 260	8 960	5 180	*5 910	3 520	*5 000	3 480			
4 outrigger down (over rear)	*15 570	*15 570	*21 380	20 480	*13 490	9 820	9 250	6 090	*5 910	4 150	*5 000	4 100				
-3.0 m	Rear blade up (over front)	*26 430	*26 430	14 800	7 810	7 300	4 210	4 530	2 600			4 060	2 320	6.43		
	Rear blade down (over rear)	*26 430	*26 430	*22 280	9 150	*13 940	4 840	*9 060	3 010			*6 820	2 690			
	Rear outrigger down (over rear)	*26 430	*26 430	*22 280	11 460	13 660	5 890	7 870	3 670			*6 820	3 280			
	Front outrigger and rear blade down (over rear)	*26 430	*26 430	*22 280	16 030	*13 940	7 800	*9 060	4 840			*6 820	4 340			
	Front blade and rear outrigger down (over rear)	*26 430	*26 430	*22 280	16 580	*13 940	8 010	8 740	4 960			*6 820	4 440			
4 outrigger down (over rear)	*26 430	*26 430	*22 280	20 900	*13 940	9 560	9 030	5 860			*6 820	5 250				

**ZX220W-7 2-PIECE BOOM, ARM 2.61 M, 2 600 KG COUNTERWEIGHT, WIDE GAUGE**

Rating over-front or rear   Rating over-side or 360 degrees   Unit : kg

Load point height (m)	Stabilization	Load radius										At max. reach		
		1.5 m		3.0 m		4.5 m		6.0 m		7.5 m				meter
7.5 m	Rear blade up (over front)											*4 480	3 740	5.87
	Rear blade down (over rear)											*4 480	4 190	
	Rear outrigger down (over rear)											*4 480	*4 480	
	Front outrigger and rear blade down (over rear)											*4 480	*4 480	
	Front blade and rear outrigger down (over rear)											*4 480	*4 480	
	4 outrigger down (over rear)											*4 480	*4 480	
6.0 m	Rear blade up (over front)							5 410	3 770			3 940	2 680	7.09
	Rear blade down (over rear)							*6 670	4 210			*3 960	3 020	
	Rear outrigger down (over rear)							*6 670	4 980			*3 960	3 610	
	Front outrigger and rear blade down (over rear)							*6 670	6 230			*3 960	*3 960	
	Front blade and rear outrigger down (over rear)							*6 670	6 350			*3 960	*3 960	
	4 outrigger down (over rear)							*6 670	*6 670			*3 960	*3 960	
4.5 m	Rear blade up (over front)					*8 220	5 670	*5 350	3 730	3 590	2 430	3 290	2 200	7.82
	Rear blade down (over rear)					*8 440	6 380	*7 200	4 170	*5 750	2 740	*3 780	2 490	
	Rear outrigger down (over rear)					*8 440	7 600	*7 200	4 940	*5 750	3 280	*3 780	3 000	
	Front outrigger and rear blade down (over rear)					*8 440	*8 440	*7 200	6 150	*5 750	4 200	*3 780	*3 780	
	Front blade and rear outrigger down (over rear)					*8 440	*8 440	*7 200	6 270	*5 750	4 290	*3 780	*3 780	
	4 outrigger down (over rear)					*8 440	*8 440	*7 200	*7 200	*5 750	5 010	*3 780	*3 780	
3.0 m	Rear blade up (over front)					7 970	5 470	5 290	3 680	3 580	2 420	2 980	1 960	8.2
	Rear blade down (over rear)					*10 650	6 160	*8 130	4 120	6 720	2 730	*3 780	2 230	
	Rear outrigger down (over rear)					*10 650	7 370	*8 130	4 880	5 790	3 270	*3 780	2 710	
	Front outrigger and rear blade down (over rear)					*10 650	9 260	*8 130	6 070	*6 960	4 180	*3 780	3 510	
	Front blade and rear outrigger down (over rear)					*10 650	9 460	*8 130	6 180	6 420	4 280	*3 780	3 590	
	4 outrigger down (over rear)					*10 650	*10 650	*8 130	7 110	6 640	*4 990	*3 780	*3 780	
1.5 m	Rear blade up (over front)			*14 600	9 710	7 860	5 360	5 300	3 660	3 490	2 330	2 870	1 870	8.28
	Rear blade down (over rear)			*14 600	11 240	*12 580	6 060	*9 070	4 100	6 640	2 650	*3 950	2 130	
	Rear outrigger down (over rear)			*14 600	13 730	*12 580	*7 260	*8 190	4 860	5 700	3 190	*3 950	2 600	
	Front outrigger and rear blade down (over rear)			*14 600	*14 600	*12 580	9 140	*9 070	6 050	*7 360	4 100	*3 950	3 390	
	Front blade and rear outrigger down (over rear)			*14 600	*14 600	*12 580	9 330	8 910	6 170	6 330	4 190	*3 950	3 470	
	4 outrigger down (over rear)			*14 600	*14 600	*12 580	10 880	*9 070	7 070	6 560	4 910	*3 950	*3 950	
0 m (Ground)	Rear blade up (over front)	*8 830	*8 830	15 050	9 500	7 860	5 260	5 090	3 470	3 360	2 210	2 930	1 890	8.08
	Rear blade down (over rear)	*8 830	*8 830	*17 810	11 020	*13 340	5 950	9 400	3 910	6 510	2 520	*4 310	2 170	
	Rear outrigger down (over rear)	*8 830	*8 830	*17 810	13 870	13 080	7 180	8 270	4 670	5 570	3 060	*4 310	2 650	
	Front outrigger and rear blade down (over rear)	*8 830	*8 830	*17 810	*17 810	*13 340	*9 140	*9 620	5 940	7 460	3 970	*4 310	3 470	
	Front blade and rear outrigger down (over rear)	*8 830	*8 830	*17 810	*17 810	*13 340	9 350	8 950	*6 070	6 210	4 060	*4 310	3 550	
	4 outrigger down (over rear)	*8 830	*8 830	*17 810	*17 810	*13 340	10 940	9 190	*7 060	6 440	4 780	*4 310	4 190	
-1.5 m	Rear blade up (over front)	*15 570	*15 570	14 950	9 090	7 590	5 010	4 780	3 180	3 240	2 100	3 210	2 070	7.56
	Rear blade down (over rear)	*15 570	*15 570	*21 380	10 580	*13 490	5 700	9 620	3 610	*5 910	2 410	*5 000	2 380	
	Rear outrigger down (over rear)	*15 570	*15 570	*21 380	13 380	*13 310	6 910	8 120	4 360	5 440	2 940	*5 000	2 900	
	Front outrigger and rear blade down (over rear)	*15 570	*15 570	*21 380	18 790	*13 490	9 050	*9 780	5 650	*5 910	3 840	*5 000	3 800	
	Front blade and rear outrigger down (over rear)	*15 570	*15 570	*21 380	19 270	*13 490	9 280	9 010	5 780	*5 910	3 940	*5 000	3 890	
	4 outrigger down (over rear)	*15 570	*15 570	*21 380	*21 380	*13 490	11 150	9 320	6 820	*5 910	4 650	*5 000	4 600	
-3.0 m	Rear blade up (over front)	*26 430	*26 430	14 880	9 030	7 350	4 790	4 560	2 980			4 090	2 660	6.43
	Rear blade down (over rear)	*26 430	*26 430	*22 280	10 520	*13 940	5 470	*9 060	3 400			*6 820	3 040	
	Rear outrigger down (over rear)	*26 430	*26 430	*22 280	13 320	13 700	6 670	7 900	4 140			*6 820	3 710	
	Front outrigger and rear blade down (over rear)	*26 430	*26 430	*22 280	18 720	*13 940	8 790	*9 060	5 420			*6 820	4 850	
	Front blade and rear outrigger down (over rear)	*26 430	*26 430	*22 280	19 380	*13 940	9 030	8 790	5 550			*6 820	4 970	
	4 outrigger down (over rear)	*26 430	*26 430	*22 280	*22 280	*13 940	10 870	*9 060	6 590			*6 820	5 900	

# MACHINE CAPACITIES

## ZX220W-7

- Notes:
1. Ratings are based on ISO 10567 : 2007.
  2. Machine capacity does not exceed 75% of tipping load with the machine on firm, level ground or 87% full hydraulic capacity.
  3. The load point is the center-line of the bucket pivot mounting pin on the arm.
  4. \*Indicates load limited by hydraulic capacity.
  5. Each value with Rear blade up over the Front-axle side and each value with Rear blade down over the Rear-axle side respectively, and value in optimal position with positioning cylinder.
  6. 0 m = Ground.

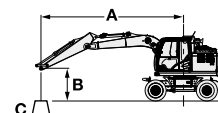

- A: Load radius  
B: Load point height  
C: Machine capacity

For machine capacities, subtract installed attachment and quick hitch weight from machine capacities.

To determine lifting capacities, apply "Rating over-side or 360 degrees" machine capacities from the table and deduct weight of installed attachment and quick hitch.

Optional feature may affect machine performance.

### ZX220W-7 2-PIECE BOOM, ARM 2.61 M, 4 300 KG COUNTERWEIGHT, STANDARD GAUGE

Rating over-front or rear Rating over-side or 360 degrees Unit : kg

Load point height (m)	Stabilization	Load radius										At max. reach		meter	
		1.5 m		3.0 m		4.5 m		6.0 m		7.5 m					
7.5 m	Rear blade up (over front)												*4 480	4 250	5.87
	Rear blade down (over rear)												*4 480	*4 480	
	Rear outrigger down (over rear)												*4 480	*4 480	
	Front outrigger and rear blade down (over rear)												*4 480	*4 480	
	Front blade and rear outrigger down (over rear)												*4 480	*4 480	
4 outrigger down (over rear)												*4 480	*4 480		
6.0 m	Rear blade up (over front)							6 400	4 270				*3 960	3 110	7.09
	Rear blade down (over rear)							*6 670	4 750				*3 960	3 470	
	Rear outrigger down (over rear)							*6 670	5 490				*3 960	*3 960	
	Front outrigger and rear blade down (over rear)							*6 670	*6 670				*3 960	*3 960	
	Front blade and rear outrigger down (over rear)							*6 670	*6 670				*3 960	*3 960	
4 outrigger down (over rear)							*6 670	*6 670				*3 960	*3 960		
4.5 m	Rear blade up (over front)					*8 440	6 330	6 320	4 240	4 390	2 830		*3 780	2 590	7.82
	Rear blade down (over rear)					*8 440	7 080	*7 200	4 710	*5 750	3 170		*3 780	2 910	
	Rear outrigger down (over rear)					*8 440	8 200	*7 200	5 440	*5 750	3 710		*3 780	3 410	
	Front outrigger and rear blade down (over rear)					*8 440	*8 440	*7 200	6 620	*5 750	4 630		*3 780	*3 780	
	Front blade and rear outrigger down (over rear)					*8 440	*8 440	*7 200	6 740	*5 750	4 720		*3 780	*3 780	
4 outrigger down (over rear)					*8 440	*8 440	*7 200	*7 200	*5 750	5 410		*3 780	*3 780		
3.0 m	Rear blade up (over front)					9 350	6 130	6 240	4 180	4 380	2 820	3 710	2 330	8.2	
	Rear blade down (over rear)					*10 650	6 870	*8 130	4 650	*6 960	3 160		*3 780		2 630
	Rear outrigger down (over rear)					*10 650	7 960	*8 130	5 370	*6 840	3 700		*3 780		3 100
	Front outrigger and rear blade down (over rear)					*10 650	9 830	*8 130	6 530	*6 960	4 610		*3 780		*3 780
	Front blade and rear outrigger down (over rear)					*10 650	10 030	*8 130	6 650	*6 960	4 710		*3 780		*3 780
4 outrigger down (over rear)					*10 650	*10 650	*8 130	7 530	*6 960	5 390		*3 780	*3 780		
1.5 m	Rear blade up (over front)			*14 600	10 650	9 230	6 030	6 220	4 160	4 300	2 740	3 590	2 240	8.28	
	Rear blade down (over rear)			*14 600	12 130	*12 580	6 770	*9 070	4 630	*7 360	3 080		*3 950		2 530
	Rear outrigger down (over rear)			*14 600	14 440	*12 580	7 860	*9 070	*5 360	6 780	3 610		*3 950		2 990
	Front outrigger and rear blade down (over rear)			*14 600	*14 600	*12 580	9 710	*9 070	6 510	*7 360	4 530		*3 950		3 790
	Front blade and rear outrigger down (over rear)			*14 600	*14 600	*12 580	*9 910	*9 070	6 630	*7 320	*4 620		*3 950		3 870
4 outrigger down (over rear)			*14 600	*14 600	*12 580	11 340	*9 070	7 490	*7 360	5 310		*3 950	*3 950		
0 m (Ground)	Rear blade up (over front)	*8 830	*8 830	17 800	10 460	9 250	5 930	6 130	3 980	4 170	2 620	3 670	2 270	8.08	
	Rear blade down (over rear)	*8 830	*8 830	*17 810	12 020	*13 340	6 670	*9 620	4 450	*7 570	2 960		*4 310		2 570
	Rear outrigger down (over rear)	*8 830	*8 830	*17 810	14 410	*13 340	7 860	9 420	5 190	6 660	3 490		*4 310		3 050
	Front outrigger and rear blade down (over rear)	*8 830	*8 830	*17 810	*17 810	*13 340	9 760	*9 620	6 450	*7 570	4 410		*4 310		3 880
	Front blade and rear outrigger down (over rear)	*8 830	*8 830	*17 810	*17 810	*13 340	9 980	*9 620	6 580	7 280	4 500		*4 310		3 960
4 outrigger down (over rear)	*8 830	*8 830	*17 810	*17 810	*13 340	*11 410	*9 620	7 510	7 490	5 180		*4 310	*4 310		
-1.5 m	Rear blade up (over front)	*15 570	*15 570	18 030	10 060	9 180	5 690	5 860	3 700	4 050	2 510	4 010	2 480	7.56	
	Rear blade down (over rear)	*15 570	*15 570	*21 380	11 610	*13 490	6 420	*9 780	4 160	*5 910	2 840		*5 000		2 810
	Rear outrigger down (over rear)	*15 570	*15 570	*21 380	14 260	*13 490	7 600	9 640	4 890	*5 910	3 370		*5 000		3 330
	Front outrigger and rear blade down (over rear)	*15 570	*15 570	*21 380	19 240	*13 490	9 730	*9 780	6 190	*5 910	4 290		*5 000		4 240
	Front blade and rear outrigger down (over rear)	*15 570	*15 570	*21 380	19 800	*13 490	9 960	*9 780	6 320	*5 910	4 380		*5 000		4 330
4 outrigger down (over rear)	*15 570	*15 570	*21 380	*21 380	*13 490	11 700	*9 780	7 300	*5 910	5 070		*5 000	*5 000		
-3.0 m	Rear blade up (over front)	*26 430	*26 430	17 960	10 010	8 940	5 480	5 630	3 500			5 070	3 140	6.43	
	Rear blade down (over rear)	*26 430	*26 430	*22 280	11 550	*13 940	6 200	*9 060	3 950				*6 820		3 560
	Rear outrigger down (over rear)	*26 430	*26 430	*22 280	14 190	*13 940	7 370	*9 060	4 680				*6 820		4 210
	Front outrigger and rear blade down (over rear)	*26 430	*26 430	*22 280	19 340	*13 940	9 480	*9 060	5 960				*6 820		5 370
	Front blade and rear outrigger down (over rear)	*26 430	*26 430	*22 280	19 960	*13 940	9 720	*9 060	6 100				*6 820		5 490
4 outrigger down (over rear)	*26 430	*26 430	*22 280	*22 280	*13 940	11 440	*9 060	7 090				*6 820	6 370		



**ZX220W-7 2-PIECE BOOM, ARM 2.61 M, 4 300 KG COUNTERWEIGHT, WIDE GAUGE**

Rating over-front or rear   Rating over-side or 360 degrees   Unit : kg

Load point height (m)	Stabilization	Load radius										At max. reach		
		1.5 m		3.0 m		4.5 m		6.0 m		7.5 m				meter
7.5 m	Rear blade up (over front)											*4 480	*4 480	5.87
	Rear blade down (over rear)											*4 480	*4 480	
	Rear outrigger down (over rear)											*4 480	*4 480	
	Front outrigger and rear blade down (over rear)											*4 480	*4 480	
	Front blade and rear outrigger down (over rear)											*4 480	*4 480	
	4 outrigger down (over rear)											*4 480	*4 480	
6.0 m	Rear blade up (over front)							6 430	4 710			*3 960	3 440	7.09
	Rear blade down (over rear)							*6 670	5 200			*3 960	3 820	
	Rear outrigger down (over rear)							*6 670	6 000			*3 960	*3 960	
	Front outrigger and rear blade down (over rear)							*6 670	*6 670			*3 960	*3 960	
	Front blade and rear outrigger down (over rear)							*6 670	*6 670			*3 960	*3 960	
	4 outrigger down (over rear)							*6 670	*6 670			*3 960	*3 960	
4.5 m	Rear blade up (over front)					*8 440	7 020	6 350	4 670	4 410	3 140	*3 780	2 880	7.82
	Rear blade down (over rear)					*8 440	*7 760	*7 200	5 160	*5 750	3 490	*3 780	3 210	
	Rear outrigger down (over rear)					*8 440	*8 440	*7 200	5 930	*5 750	4 090	*3 780	3 770	
	Front outrigger and rear blade down (over rear)					*8 440	*8 440	*7 200	*7 200	*5 750	5 070	*3 780	*3 780	
	Front blade and rear outrigger down (over rear)					*8 440	*8 440	*7 200	*7 200	*5 750	5 180	*3 780	*3 780	
	4 outrigger down (over rear)					*8 440	*8 440	*7 200	*7 200	*5 750	*5 750	*3 780	*3 780	
3.0 m	Rear blade up (over front)					9 390	6 810	*6 260	4 610	4 400	3 130	3 720	2 610	8.2
	Rear blade down (over rear)					*10 650	7 540	*8 130	5 100	*6 960	3 480	*3 780	2 910	
	Rear outrigger down (over rear)					*10 650	8 750	*8 130	5 860	*6 860	4 080	*3 780	3 430	
	Front outrigger and rear blade down (over rear)					*10 650	*10 650	*8 130	7 100	*6 960	5 060	*3 780	*3 780	
	Front blade and rear outrigger down (over rear)					*10 650	*10 650	*8 130	7 230	*6 960	5 160	*3 780	*3 780	
	4 outrigger down (over rear)					*10 650	*10 650	*8 130	*8 130	*6 960	5 930	*3 780	*3 780	
1.5 m	Rear blade up (over front)			*14 600	12 020	9 280	6 710	6 250	4 600	4 320	3 050	3 600	2 510	8.28
	Rear blade down (over rear)			*14 600	13 540	*12 580	7 450	*9 070	5 090	*7 360	3 400	*3 950	2 810	
	Rear outrigger down (over rear)			*14 600	*14 600	*12 580	8 640	*9 070	5 850	6 800	3 990	*3 950	3 320	
	Front outrigger and rear blade down (over rear)			*14 600	*14 600	*12 580	10 650	*9 070	7 070	*7 360	4 970	*3 950	*3 950	
	Front blade and rear outrigger down (over rear)			*14 600	*14 600	*12 580	10 860	*9 070	7 190	7 350	5 080	*3 950	*3 950	
	4 outrigger down (over rear)			*14 600	*14 600	*12 580	*12 500	*9 070	8 170	*7 360	5 850	*3 950	*3 950	
0 m (Ground)	Rear blade up (over front)	*8 830	*8 830	*17 810	11 880	9 290	6 600	6 160	4 410	4 190	2 930	3 690	2 550	8.08
	Rear blade down (over rear)	*8 830	*8 830	*17 810	13 630	*13 340	7 390	*9 620	4 900	*7 570	3 280	*4 310	2 860	
	Rear outrigger down (over rear)	*8 830	*8 830	*17 810	16 380	*13 340	8 600	*9 430	5 720	6 680	3 870	*4 310	3 390	
	Front outrigger and rear blade down (over rear)	*8 830	*8 830	*17 810	*17 810	*13 340	10 710	*9 620	*7 060	*7 570	4 850	*4 310	4 280	
	Front blade and rear outrigger down (over rear)	*8 830	*8 830	*17 810	*17 810	*13 340	*10 930	*9 620	7 190	7 310	4 950	*4 310	*4 310	
	4 outrigger down (over rear)	*8 830	*8 830	*17 810	*17 810	*13 340	12 550	*9 620	8 250	7 540	5 730	*4 310	*4 310	
-1.5 m	Rear blade up (over front)	*15 570	*15 570	18 110	11 470	9 220	6 360	5 880	4 120	4 070	2 820	4 030	2 780	7.56
	Rear blade down (over rear)	*15 570	*15 570	*21 380	13 190	*13 490	7 130	*9 780	4 600	*5 910	3 160	*5 000	3 120	
	Rear outrigger down (over rear)	*15 570	*15 570	*21 380	16 380	*13 490	8 480	9 660	5 430	*5 910	3 750	*5 000	3 700	
	Front outrigger and rear blade down (over rear)	*15 570	*15 570	*21 380	*21 380	*13 490	10 850	*9 780	6 820	*5 910	4 730	*5 000	4 680	
	Front blade and rear outrigger down (over rear)	*15 570	*15 570	*21 380	*21 380	*13 490	11 110	*9 780	6 970	*5 910	4 830	*5 000	4 780	
	4 outrigger down (over rear)	*15 570	*15 570	*21 380	*21 380	*13 490	*12 800	*9 780	8 100	*5 910	5 610	*5 000	*5 000	
-3.0 m	Rear blade up (over front)	*26 430	*26 430	18 050	11 410	8 980	6 140	5 660	3 910			5 100	3 520	6.43
	Rear blade down (over rear)	*26 430	*26 430	*22 280	13 130	*13 940	6 900	*9 060	4 390			*6 820	3 950	
	Rear outrigger down (over rear)	*26 430	*26 430	*22 280	16 310	*13 940	8 250	*9 060	5 210			*6 820	4 690	
	Front outrigger and rear blade down (over rear)	*26 430	*26 430	*22 280	*22 260	*13 940	10 590	*9 060	6 610			*6 820	5 940	
	Front blade and rear outrigger down (over rear)	*26 430	*26 430	*22 280	*22 280	*13 940	10 850	*9 060	6 750			*6 820	6 070	
	4 outrigger down (over rear)	*26 430	*26 430	*22 280	*22 280	*13 940	12 890	*9 060	7 900			*6 820	*6 820	

# MACHINE CAPACITIES

## ZX220W-7

- Notes:
1. Ratings are based on ISO 10567 : 2007.
  2. Machine capacity does not exceed 75% of tipping load with the machine on firm, level ground or 87% full hydraulic capacity.
  3. The load point is the center-line of the bucket pivot mounting pin on the arm.
  4. \*Indicates load limited by hydraulic capacity.
  5. Each value with Rear blade up over the Front-axle side and each value with Rear blade down over the Rear-axle side respectively, and value in optimal position with positioning cylinder.
  6. 0 m = Ground.

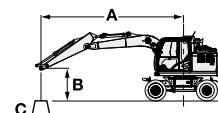

- A: Load radius  
B: Load point height  
C: Machine capacity

For machine capacities, subtract installed attachment and quick hitch weight from machine capacities.

To determine lifting capacities, apply "Rating over-side or 360 degrees" machine capacities from the table and deduct weight of installed attachment and quick hitch.

Optional feature may affect machine performance.

### ZX220W-7 2-PIECE BOOM, ARM 2.61 M, 5 000 KG COUNTERWEIGHT, STANDARD GAUGE

Rating over-front or rear Rating over-side or 360 degrees Unit : kg

Load point height (m)	Stabilization	Load radius										At max. reach		meter		
		1.5 m		3.0 m		4.5 m		6.0 m		7.5 m						
7.5 m	Rear blade up (over front)													*4 480	*4 480	5.87
	Rear blade down (over rear)													*4 480	*4 480	
	Rear outrigger down (over rear)													*4 480	*4 480	
	Front outrigger and rear blade down (over rear)													*4 480	*4 480	
	Front blade and rear outrigger down (over rear)													*4 480	*4 480	
	4 outrigger down (over rear)													*4 480	*4 480	
6.0 m	Rear blade up (over front)							*6 670	4 640					*3 960	3 410	7.09
	Rear blade down (over rear)							*6 670	5 130					*3 960	3 790	
	Rear outrigger down (over rear)							*6 670	5 880					*3 960	*3 960	
	Front outrigger and rear blade down (over rear)							*6 670	*6 670					*3 960	*3 960	
	Front blade and rear outrigger down (over rear)							*6 670	*6 670					*3 960	*3 960	
	4 outrigger down (over rear)							*6 670	*6 670					*3 960	*3 960	
4.5 m	Rear blade up (over front)					*8 440	6 850	6 730	4 600	4 730	3 120			*3 780	2 860	7.82
	Rear blade down (over rear)					*8 440	*7 610	*7 200	5 090	*5 750	3 470			*3 780	3 190	
	Rear outrigger down (over rear)					*8 440	*8 440	*7 200	5 820	*5 750	4 020			*3 780	3 710	
	Front outrigger and rear blade down (over rear)					*8 440	*8 440	*7 200	7 040	*5 750	4 970			*3 780	*3 780	
	Front blade and rear outrigger down (over rear)					*8 440	*8 440	*7 200	7 160	*5 750	5 070			*3 780	*3 780	
	4 outrigger down (over rear)					*8 440	*8 440	*7 200	*7 200	*5 750	*5 750			*3 780	*3 780	
3.0 m	Rear blade up (over front)					9 930	6 650	6 640	4 550	4 720	3 110			*3 780	2 590	8.2
	Rear blade down (over rear)					*10 650	7 390	*8 130	5 040	*6 960	3 460			*3 780	2 900	
	Rear outrigger down (over rear)					*10 650	*8 500	*8 130	5 740	*6 960	4 010			*3 780	3 390	
	Front outrigger and rear blade down (over rear)					*10 650	10 420	*8 130	*6 940	*6 960	4 960			*3 780	*3 780	
	Front blade and rear outrigger down (over rear)					*10 650	10 630	*8 130	*7 060	*6 960	5 050			*3 780	*3 780	
	4 outrigger down (over rear)					*10 650	*10 650	*8 130	7 970	*6 960	5 760			*3 780	*3 780	
1.5 m	Rear blade up (over front)			*14 600	11 560	9 820	6 550	6 610	4 530	4 630	3 030			3 890	2 490	8.28
	Rear blade down (over rear)			*14 600	12 990	*12 580	7 300	*9 070	5 020	*7 360	3 370			*3 950	2 790	
	Rear outrigger down (over rear)			*14 600	*14 600	*12 580	*8 400	*9 070	*5 740	7 200	3 930			*3 950	3 270	
	Front outrigger and rear blade down (over rear)			*14 600	*14 600	*12 580	10 300	*9 070	6 910	*7 360	4 870			*3 950	*3 950	
	Front blade and rear outrigger down (over rear)			*14 600	*14 600	*12 580	10 500	*9 070	7 030	*7 360	4 970			*3 950	*3 950	
	4 outrigger down (over rear)			*14 600	*14 600	*12 580	11 970	*9 070	7 910	*7 360	5 680			*3 950	*3 950	
0 m (Ground)	Rear blade up (over front)	*8 830	*8 830	*17 810	11 360	9 860	6 450	6 560	4 350	4 510	2 910			3 980	2 530	8.08
	Rear blade down (over rear)	*8 830	*8 830	*17 810	13 010	*13 340	7 220	*9 620	4 830	*7 570	3 250			*4 310	2 850	
	Rear outrigger down (over rear)	*8 830	*8 830	*17 810	*15 460	*13 340	*8 460	*9 620	5 600	7 120	3 800			*4 310	3 340	
	Front outrigger and rear blade down (over rear)	*8 830	*8 830	*17 810	*17 810	*13 340	10 360	*9 620	6 880	*7 570	4 750			*4 310	4 200	
	Front blade and rear outrigger down (over rear)	*8 830	*8 830	*17 810	*17 810	*13 340	10 560	*9 620	7 020	*7 570	4 850			*4 310	4 280	
	4 outrigger down (over rear)	*8 830	*8 830	*17 810	*17 810	*13 340	*12 030	*9 620	7 980	*7 570	5 550			*4 310	*4 310	
-1.5 m	Rear blade up (over front)	*15 570	*15 570	*19 180	10 970	9 850	6 210	6 310	4 060	4 390	2 790			4 350	2 760	7.56
	Rear blade down (over rear)	*15 570	*15 570	*21 380	12 600	*13 490	6 970	*9 780	4 540	*5 910	3 140			*5 000	3 100	
	Rear outrigger down (over rear)	*15 570	*15 570	*21 380	15 380	*13 490	8 210	*9 780	5 310	*5 910	3 690			*5 000	3 650	
	Front outrigger and rear blade down (over rear)	*15 570	*15 570	*21 380	20 360	*13 490	10 420	*9 780	6 640	*5 910	4 640			*5 000	4 680	
	Front blade and rear outrigger down (over rear)	*15 570	*15 570	*21 380	20 860	*13 490	10 670	*9 780	6 780	*5 910	4 730			*5 000	4 680	
	4 outrigger down (over rear)	*15 570	*15 570	*21 380	*21 380	*13 490	12 240	*9 780	7 800	*5 910	5 440			*5 000	*5 000	
-3.0 m	Rear blade up (over front)	*26 430	*26 430	19 270	10 910	9 610	6 000	6 090	3 860					5 490	3 480	6.43
	Rear blade down (over rear)	*26 430	*26 430	*22 280	12 540	*13 940	6 750	*9 060	4 340					*6 820	3 910	
	Rear outrigger down (over rear)	*26 430	*26 430	*22 280	15 320	*13 940	7 980	*9 060	5 100					*6 820	4 600	
	Front outrigger and rear blade down (over rear)	*26 430	*26 430	*22 280	20 700	*13 940	10 180	*9 060	6 430					*6 820	5 790	
	Front blade and rear outrigger down (over rear)	*26 430	*26 430	*22 280	21 360	*13 940	10 420	*9 060	6 570					*6 820	5 920	
	4 outrigger down (over rear)	*26 430	*26 430	*22 280	*22 280	*13 940	12 200	*9 060	7 600					*6 820	*6 820	

**ZX220W-7 2-PIECE BOOM, ARM 2.61 M, 5 000 KG COUNTERWEIGHT, WIDE GAUGE**

Rating over-front or rear Rating over-side or 360 degrees Unit : kg

Load point height (m)	Stabilization	Load radius										At max. reach		
		1.5 m		3.0 m		4.5 m		6.0 m		7.5 m				meter
7.5 m	Rear blade up (over front)											*4 480	*4 480	5.87
	Rear blade down (over rear)											*4 480	*4 480	
	Rear outrigger down (over rear)											*4 480	*4 480	
	Front outrigger and rear blade down (over rear)											*4 480	*4 480	
	Front blade and rear outrigger down (over rear)											*4 480	*4 480	
	4 outrigger down (over rear)											*4 480	*4 480	
6.0 m	Rear blade up (over front)							*6 670	5 090			*3 960	3 760	7.09
	Rear blade down (over rear)							*6 670	5 590			*3 960	*3 960	
	Rear outrigger down (over rear)							*6 670	6 410			*3 960	*3 960	
	Front outrigger and rear blade down (over rear)							*6 670	*6 670			*3 960	*3 960	
	Front blade and rear outrigger down (over rear)							*6 670	*6 670			*3 960	*3 960	
	4 outrigger down (over rear)							*6 670	*6 670			*3 960	*3 960	
4.5 m	Rear blade up (over front)					*8 440	7 540	6 750	5 050	4 750	3 440	*3 780	3 170	7.82
	Rear blade down (over rear)					*8 440	*8 290	*7 200	5 530	*5 750	3 800	*3 780	3 510	
	Rear outrigger down (over rear)					*8 440	*8 440	*7 200	6 330	*5 750	4 420	*3 780	*3 780	
	Front outrigger and rear blade down (over rear)					*8 440	*8 440	*7 200	*7 200	*5 750	5 430	*3 780	*3 780	
	Front blade and rear outrigger down (over rear)					*8 440	*8 440	*7 200	*7 200	*5 750	5 540	*3 780	*3 780	
	4 outrigger down (over rear)					*8 440	*8 440	*7 200	*7 200	*5 750	*5 750	*3 780	*3 780	
3.0 m	Rear blade up (over front)					9 970	7 340	6 660	5 000	4 740	3 430	*3 780	2 870	8.2
	Rear blade down (over rear)					*10 650	8 070	*8 130	5 460	*6 960	3 790	*3 780	3 190	
	Rear outrigger down (over rear)					*10 650	9 310	*8 130	6 240	*6 960	4 400	*3 780	3 730	
	Front outrigger and rear blade down (over rear)					*10 650	*10 650	*8 130	7 530	*6 960	5 420	*3 780	*3 780	
	Front blade and rear outrigger down (over rear)					*10 650	*10 650	*8 130	7 660	*6 960	5 520	*3 780	*3 780	
	4 outrigger down (over rear)					*10 650	*10 650	*8 130	*8 130	*6 960	6 320	*3 780	*3 780	
1.5 m	Rear blade up (over front)			*14 600	12 870	9 850	7 250	6 640	4 980	4 660	3 350	3 910	2 770	8.28
	Rear blade down (over rear)			*14 600	14 440	*12 580	7 960	*9 070	5 460	*7 360	3 710	*3 950	3 080	
	Rear outrigger down (over rear)			*14 600	*14 600	*12 580	9 200	*9 070	6 230	7 220	4 320	*3 950	3 610	
	Front outrigger and rear blade down (over rear)			*14 600	*14 600	*12 580	11 260	*9 070	7 490	*7 360	5 330	*3 950	*3 950	
	Front blade and rear outrigger down (over rear)			*14 600	*14 600	*12 580	11 480	*9 070	7 610	*7 360	*5 440	*3 950	*3 950	
	4 outrigger down (over rear)			*14 600	*14 600	*12 580	*12 580	*9 070	8 610	*7 360	6 240	*3 950	*3 950	
0 m (Ground)	Rear blade up (over front)	*8 830	*8 830	*17 810	12 860	9 910	7 160	6 590	4 790	4 540	3 230	4 000	2 820	8.08
	Rear blade down (over rear)	*8 830	*8 830	*17 810	14 420	*13 340	7 980	*9 620	5 290	*7 570	3 590	*4 310	3 150	
	Rear outrigger down (over rear)	*8 830	*8 830	*17 810	17 450	*13 340	9 200	*9 620	6 140	*7 130	4 200	*4 310	3 700	
	Front outrigger and rear blade down (over rear)	*8 830	*8 830	*17 810	*17 810	*13 340	11 320	*9 620	7 510	*7 570	5 210	*4 310	*4 310	
	Front blade and rear outrigger down (over rear)	*8 830	*8 830	*17 810	*17 810	*13 340	11 540	*9 620	7 660	*7 570	*5 320	*4 310	*4 310	
	4 outrigger down (over rear)	*8 830	*8 830	*17 810	*17 810	*13 340	13 150	*9 620	8 670	*7 570	6 120	*4 310	*4 310	
-1.5 m	Rear blade up (over front)	*15 570	*15 570	19 250	12 450	9 890	6 910	6 340	4 510	4 420	3 110	4 370	3 080	7.56
	Rear blade down (over rear)	*15 570	*15 570	*21 380	14 270	*13 490	7 720	*9 780	5 010	*5 910	3 470	*5 000	3 430	
	Rear outrigger down (over rear)	*15 570	*15 570	*21 380	17 620	*13 490	9 130	*9 780	5 870	*5 910	4 080	*5 000	4 030	
	Front outrigger and rear blade down (over rear)	*15 570	*15 570	*21 380	*21 380	*13 490	11 590	*9 780	7 300	*5 910	5 100	*5 000	*5 000	
	Front blade and rear outrigger down (over rear)	*15 570	*15 570	*21 380	*21 380	*13 490	*11 770	*9 780	7 460	*5 910	5 200	*5 000	*5 000	
	4 outrigger down (over rear)	*15 570	*15 570	*21 380	*21 380	*13 490	13 350	*9 780	8 640	*5 910	*5 910	*5 000	*5 000	
-3.0 m	Rear blade up (over front)	*26 430	*26 430	19 350	12 390	9 650	6 690	6 120	4 300			5 510	3 880	6.43
	Rear blade down (over rear)	*26 430	*26 430	*22 280	14 210	*13 940	7 490	*9 060	4 800			*6 820	4 330	
	Rear outrigger down (over rear)	*26 430	*26 430	*22 280	17 550	*13 940	8 900	*9 060	5 650			*6 820	5 090	
	Front outrigger and rear blade down (over rear)	*26 430	*26 430	*22 280	*22 280	*13 940	11 330	*9 060	7 100			*6 820	6 390	
	Front blade and rear outrigger down (over rear)	*26 430	*26 430	*22 280	*22 280	*13 940	11 600	*9 060	7 250			*6 820	6 520	
	4 outrigger down (over rear)	*26 430	*26 430	*22 280	*22 280	*13 940	13 710	*9 060	8 430			*6 820	*6 820	



# MACHINE CAPACITIES

## ZX220W-7

- Notes:
1. Ratings are based on ISO 10567 : 2007.
  2. Machine capacity does not exceed 75% of tipping load with the machine on firm, level ground or 87% full hydraulic capacity.
  3. The load point is the center-line of the bucket pivot mounting pin on the arm.
  4. \*Indicates load limited by hydraulic capacity.
  5. Each value with Rear blade up over the Front-axle side and each value with Rear blade down over the Rear-axle side respectively, and value in optimal position with positioning cylinder.
  6. 0 m = Ground.

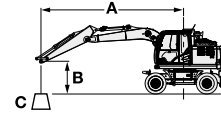

- A: Load radius  
B: Load point height  
C: Machine capacity

For machine capacities, subtract installed attachment and quick hitch weight from machine capacities.

To determine lifting capacities, apply "Rating over-side or 360 degrees" machine capacities from the table and deduct weight of installed attachment and quick hitch.

Optional feature may affect machine performance.













### ZX220W-7 2-PIECE BOOM, ARM 2.91 M, 2 600 KG COUNTERWEIGHT, STANDARD GAUGE

Rating over-front or rear Rating over-side or 360 degrees Unit : kg

Load point height (m)	Stabilization	Load radius										At max. reach				
		1.5 m		3.0 m		4.5 m		6.0 m		7.5 m				meter		
7.5 m	Rear blade up (over front)							*4 890	3 300					*3 880	3 040	6.25
	Rear blade down (over rear)							*4 890	3 720					*3 880	3 430	
	Rear outrigger down (over rear)							*4 890	4 400					*3 880	*3 880	
	Front outrigger and rear blade down (over rear)							*4 890	*4 890					*3 880	*3 880	
	Front blade and rear outrigger down (over rear)							*4 890	*4 890					*3 880	*3 880	
	4 outrigger down (over rear)							*4 890	*4 890					*3 880	*3 880	
6.0 m	Rear blade up (over front)							5 400	3 410					*3 490	2 220	7.4
	Rear blade down (over rear)							*6 110	3 830					*3 490	2 520	
	Rear outrigger down (over rear)							*6 110	4 520					*3 490	3 020	
	Front outrigger and rear blade down (over rear)							*6 110	5 690					*3 490	*3 490	
	Front blade and rear outrigger down (over rear)							*6 110	5 810					*3 490	*3 490	
	4 outrigger down (over rear)							*6 110	*6 110					*3 490	*3 490	
4.5 m	Rear blade up (over front)					*7 210	5 090	5 330	3 340	3 630	2 210			*3 100	1 820	8.1
	Rear blade down (over rear)					*7 210	5 750	*6 880	3 770	*5 730	2 510			*3 350	2 090	
	Rear outrigger down (over rear)					*7 210	6 840	*6 880	4 450	*5 730	3 000			*3 350	2 530	
	Front outrigger and rear blade down (over rear)					*7 210	*7 210	*6 880	5 620	*5 730	3 850			*3 350	3 300	
	Front blade and rear outrigger down (over rear)					*7 210	*7 210	*6 880	5 730	*5 730	3 940			*3 350	*3 350	
	4 outrigger down (over rear)					*7 210	*7 210	*6 880	6 560	*5 730	4 570			*3 350	*3 350	
3.0 m	Rear blade up (over front)			*11 610	8 730	7 950	4 860	5 250	3 270	3 620	2 190			*3 360	1 620	8.47
	Rear blade down (over rear)			*11 610	10 130	*10 150	5 520	*7 850	3 690	6 690	2 500			*3 360	1 870	
	Rear outrigger down (over rear)			*11 610	*11 610	*10 150	6 600	*7 850	4 370	5 810	2 990			*3 360	2 280	
	Front outrigger and rear blade down (over rear)			*11 610	*11 610	*10 150	8 390	*7 850	5 520	*6 760	3 840			*3 360	3 000	
	Front blade and rear outrigger down (over rear)			*11 610	*11 610	*10 150	8 580	*7 850	5 630	6 400	3 920			*3 360	3 070	
	4 outrigger down (over rear)			*11 610	*11 610	*10 150	9 940	*7 850	6 450	*6 590	4 540			*3 360	*3 360	
1.5 m	Rear blade up (over front)			*14 600	8 440	7 810	4 740	5 220	3 250	3 530	2 110			*3 520	1 530	8.55
	Rear blade down (over rear)			*14 600	9 820	*12 230	5 390	*8 860	3 670	6 650	2 410			*3 520	1 780	
	Rear outrigger down (over rear)			*14 600	12 090	*12 230	6 460	8 140	4 350	5 730	2 900			*3 520	2 190	
	Front outrigger and rear blade down (over rear)			*14 600	*14 600	*12 230	8 250	*8 860	5 490	*7 200	3 750			*3 520	2 890	
	Front blade and rear outrigger down (over rear)			*14 600	*14 600	*12 230	*8 430	8 850	5 600	6 330	3 830			*3 520	2 960	
	4 outrigger down (over rear)			*14 600	*14 600	*12 230	*9 770	*8 860	6 400	6 540	4 460			*3 520	3 480	
0 m (Ground)	Rear blade up (over front)	*8 850	*8 850	*14 990	8 360	7 760	4 700	5 090	3 110	3 390	1 970			*2 760	1 540	8.35
	Rear blade down (over rear)	*8 850	*8 850	*17 310	9 730	*13 250	5 350	*9 330	3 520	6 520	2 270			*3 840	1 800	
	Rear outrigger down (over rear)	*8 850	*8 850	*17 310	12 100	13 000	6 430	*8 180	4 200	5 590	2 760			*3 840	2 220	
	Front outrigger and rear blade down (over rear)	*8 850	*8 850	*17 310	16 080	*13 250	8 220	*9 520	5 400	*7 420	3 600			*3 840	2 940	
	Front blade and rear outrigger down (over rear)	*8 850	*8 850	*17 310	*16 540	*13 250	8 410	8 860	5 520	6 200	3 690			*3 840	3 020	
	4 outrigger down (over rear)	*8 850	*8 850	*17 310	*17 310	*13 250	9 790	*9 090	6 440	6 410	4 320			*3 840	3 550	
-1.5 m	Rear blade up (over front)	*14 430	*14 430	14 910	7 880	7 560	4 430	4 810	2 860	3 240	1 840			*2 990	1 680	7.85
	Rear blade down (over rear)	*14 430	*14 430	*20 810	9 230	*13 420	5 070	*9 500	3 270	6 380	2 130			*4 440	1 960	
	Rear outrigger down (over rear)	*14 430	*14 430	*20 810	11 560	13 190	6 130	8 150	3 940	5 440	2 610			*4 440	2 410	
	Front outrigger and rear blade down (over rear)	*14 430	*14 430	*20 810	16 140	*13 420	8 060	*9 700	5 120	7 290	3 460			*4 440	3 200	
	Front blade and rear outrigger down (over rear)	*14 430	*14 430	*20 810	16 690	*13 420	8 270	9 000	5 240	6 060	3 540			*4 440	3 280	
	4 outrigger down (over rear)	*14 430	*14 430	*20 810	20 320	*13 420	9 830	9 300	6 150	*6 270	4 170			*4 440	3 860	
-3.0 m	Rear blade up (over front)	*23 060	*23 060	14 740	7 760	7 360	4 260	4 550	2 620					3 630	2 050	6.9
	Rear blade down (over rear)	*23 060	*23 060	*22 080	9 090	*13 790	4 890	9 380	3 020					*5 750	2 390	
	Rear outrigger down (over rear)	*23 060	*23 060	*22 080	11 410	13 740	5 950	7 890	3 680					*5 750	2 920	
	Front outrigger and rear blade down (over rear)	*23 060	*23 060	*22 080	15 970	*13 790	7 860	*9 570	4 860					*5 750	3 870	
	Front blade and rear outrigger down (over rear)	*23 060	*23 060	*22 080	16 520	*13 790	8 070	8 750	4 980					*5 750	3 970	
	4 outrigger down (over rear)	*23 060	*23 060	*22 080	20 840	*13 790	9 630	9 050	5 880					*5 750	4 680	
-4.5 m	Rear blade up (over front)	*31 570	30 750	14 570	7 620									8 780	4 900	3.96
	Rear blade down (over rear)	*31 570	*31 570	*20 090	8 950									*13 630	5 690	
	Rear outrigger down (over rear)	*31 570	*31 570	*20 090	11 250									*13 630	6 990	
	Front outrigger and rear blade down (over rear)	*31 570	*31 570	*20 090	15 790									*13 630	9 420	
	Front blade and rear outrigger down (over rear)	*31 570	*31 570	*20 090	16 330									*13 630	9 690	
	4 outrigger down (over rear)	*31 570	*31 570	*20 090	*20 090									*13 630	11 730	

**ZX220W-7 2-PIECE BOOM, ARM 2.91 M, 2 600 KG COUNTERWEIGHT, WIDE GAUGE**

 Rating over-front or rear  Rating over-side or 360 degrees Unit : kg

Load point height (m)	Stabilization	Load radius										At max. reach					
		1.5 m		3.0 m		4.5 m		6.0 m		7.5 m				meter			
																	
7.5 m	Rear blade up (over front)																
	Rear blade down (over rear)																
	Rear outrigger down (over rear)																
	Front outrigger and rear blade down (over rear)																
	Front blade and rear outrigger down (over rear)																
	4 outrigger down (over rear)																
6.0 m	Rear blade up (over front)																
	Rear blade down (over rear)																
	Rear outrigger down (over rear)																
	Front outrigger and rear blade down (over rear)																
	Front blade and rear outrigger down (over rear)																
	4 outrigger down (over rear)																
4.5 m	Rear blade up (over front)																
	Rear blade down (over rear)																
	Rear outrigger down (over rear)																
	Front outrigger and rear blade down (over rear)																
	Front blade and rear outrigger down (over rear)																
	4 outrigger down (over rear)																
3.0 m	Rear blade up (over front)																
	Rear blade down (over rear)																
	Rear outrigger down (over rear)																
	Front outrigger and rear blade down (over rear)																
	Front blade and rear outrigger down (over rear)																
	4 outrigger down (over rear)																
1.5 m	Rear blade up (over front)																
	Rear blade down (over rear)																
	Rear outrigger down (over rear)																
	Front outrigger and rear blade down (over rear)																
	Front blade and rear outrigger down (over rear)																
	4 outrigger down (over rear)																
0 m (Ground)	Rear blade up (over front)																
	Rear blade down (over rear)																
	Rear outrigger down (over rear)																
	Front outrigger and rear blade down (over rear)																
	Front blade and rear outrigger down (over rear)																
	4 outrigger down (over rear)																
-1.5 m	Rear blade up (over front)																
	Rear blade down (over rear)																
	Rear outrigger down (over rear)																
	Front outrigger and rear blade down (over rear)																
	Front blade and rear outrigger down (over rear)																
	4 outrigger down (over rear)																
-3.0 m	Rear blade up (over front)																
	Rear blade down (over rear)																
	Rear outrigger down (over rear)																
	Front outrigger and rear blade down (over rear)																
	Front blade and rear outrigger down (over rear)																
	4 outrigger down (over rear)																
-4.5 m	Rear blade up (over front)																
	Rear blade down (over rear)																
	Rear outrigger down (over rear)																
	Front outrigger and rear blade down (over rear)																
	Front blade and rear outrigger down (over rear)																
	4 outrigger down (over rear)																

# MACHINE CAPACITIES

## ZX220W-7

- Notes:
1. Ratings are based on ISO 10567 : 2007.
  2. Machine capacity does not exceed 75% of tipping load with the machine on firm, level ground or 87% full hydraulic capacity.
  3. The load point is the center-line of the bucket pivot mounting pin on the arm.
  4. \*Indicates load limited by hydraulic capacity.
  5. Each value with Rear blade up over the Front-axle side and each value with Rear blade down over the Rear-axle side respectively, and value in optimal position with positioning cylinder.
  6. 0 m = Ground.

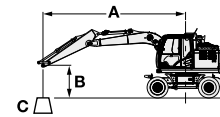

- A: Load radius  
B: Load point height  
C: Machine capacity

For machine capacities, subtract installed attachment and quick hitch weight from machine capacities.

To determine lifting capacities, apply "Rating over-side or 360 degrees" machine capacities from the table and deduct weight of installed attachment and quick hitch.

Optional feature may affect machine performance.

### ZX220W-7 2-PIECE BOOM, ARM 2.91 M, 4 300 KG COUNTERWEIGHT, STANDARD GAUGE

Rating over-front or rear Rating over-side or 360 degrees Unit : kg

Load point height (m)	Stabilization	Load radius										At max. reach		meter		
		1.5 m		3.0 m		4.5 m		6.0 m		7.5 m						
7.5 m	Rear blade up (over front)							*4 890	4 190					*3 880	*3 880	6.25
	Rear blade down (over rear)							*4 890	4 660					*3 880	*3 880	
	Rear outrigger down (over rear)							*4 890	*4 890					*3 880	*3 880	
	Front outrigger and rear blade down (over rear)							*4 890	*4 890					*3 880	*3 880	
	Front blade and rear outrigger down (over rear)							*4 890	*4 890					*3 880	*3 880	
	4 outrigger down (over rear)							*4 890	*4 890					*3 880	*3 880	
6.0 m	Rear blade up (over front)							*6 110	4 300					*3 490	2 910	7.4
	Rear blade down (over rear)							*6 110	4 770					*3 490	3 260	
	Rear outrigger down (over rear)							*6 110	5 510					*3 490	*3 490	
	Front outrigger and rear blade down (over rear)							*6 110	*6 110					*3 490	*3 490	
	Front blade and rear outrigger down (over rear)							*6 110	*6 110					*3 490	*3 490	
	4 outrigger down (over rear)							*6 110	*6 110					*3 490	*3 490	
4.5 m	Rear blade up (over front)					*7 210	6 350	6 320	4 240	4 450	2 900			*3 490	2 450	8.1
	Rear blade down (over rear)					*7 210	7 100	*6 880	4 710	*5 730	3 230			*3 350	2 750	
	Rear outrigger down (over rear)					*7 210	*7 210	*6 880	5 440	*5 730	3 770			*3 350	3 240	
	Front outrigger and rear blade down (over rear)					*7 210	*7 210	*6 880	6 630	*5 730	4 680			*3 350	*3 350	
	Front blade and rear outrigger down (over rear)					*7 210	*7 210	*6 880	6 750	*5 730	4 780			*3 350	*3 350	
	4 outrigger down (over rear)					*7 210	*7 210	*6 880	*6 880	*5 730	5 450			*3 350	*3 350	
3.0 m	Rear blade up (over front)			*11 610	10 930	*9 360	6 130	6 220	4 160	4 430	2 880			*3 360	2 220	8.47
	Rear blade down (over rear)			*11 610	*11 610	*10 150	6 870	*7 850	4 630	*6 760	3 220			*3 360	2 500	
	Rear outrigger down (over rear)			*11 610	*11 610	*10 150	*7 980	*7 850	5 360	*6 760	3 750			*3 360	2 950	
	Front outrigger and rear blade down (over rear)			*11 610	*11 610	*10 150	9 850	*7 850	6 520	*6 760	4 660			*3 360	*3 360	
	Front blade and rear outrigger down (over rear)			*11 610	*11 610	*10 150	10 050	*7 850	6 640	*6 760	4 760			*3 360	*3 360	
	4 outrigger down (over rear)			*11 610	*11 610	*10 150	*10 150	*7 850	7 520	*6 760	5 430			*3 360	*3 360	
1.5 m	Rear blade up (over front)			*14 600	10 640	9 220	6 010	*6 180	4 140	4 350	2 790			*3 420	2 120	8.55
	Rear blade down (over rear)			*14 600	12 130	*12 230	6 740	*8 860	4 610	*7 200	3 130			*3 520	2 400	
	Rear outrigger down (over rear)			*14 600	14 420	*12 230	7 840	*8 860	5 330	6 800	3 670			*3 520	2 850	
	Front outrigger and rear blade down (over rear)			*14 600	*14 600	*12 230	9 690	*8 860	6 470	*7 200	4 580			*3 520	*3 520	
	Front blade and rear outrigger down (over rear)			*14 600	*14 600	*12 230	9 890	*8 860	6 590	*7 200	*4 670			*3 520	*3 520	
	4 outrigger down (over rear)			*14 600	*14 600	*12 230	11 320	*8 860	7 450	*7 200	5 350			*3 520	*3 520	
0 m (Ground)	Rear blade up (over front)	*8 850	*8 850	*17 310	10 560	9 250	5 970	6 190	4 000	4 210	2 660			*3 490	2 150	8.35
	Rear blade down (over rear)	*8 850	*8 850	*17 310	12 140	*13 250	6 710	*9 520	4 460	*7 510	2 990			*3 840	2 440	
	Rear outrigger down (over rear)	*8 850	*8 850	*17 310	14 430	*13 250	7 800	9 370	5 210	6 690	3 530			*3 840	2 900	
	Front outrigger and rear blade down (over rear)	*8 850	*8 850	*17 310	*17 310	*13 250	9 710	*9 520	6 530	*7 510	4 440			*3 840	3 690	
	Front blade and rear outrigger down (over rear)	*8 850	*8 850	*17 310	*17 310	*13 250	9 920	*9 520	6 660	7 300	4 540			*3 840	3 770	
	4 outrigger down (over rear)	*8 850	*8 850	*17 310	*17 310	*13 250	11 350	*9 520	7 510	*7 470	5 220			*3 840	*3 840	
-1.5 m	Rear blade up (over front)	*14 430	*14 430	18 070	10 090	9 190	5 700	5 910	3 750	4 070	2 520			*3 780	2 330	7.85
	Rear blade down (over rear)	*14 430	*14 430	*20 810	11 630	*13 420	6 420	*9 700	4 210	*7 360	2 850			*4 440	2 640	
	Rear outrigger down (over rear)	*14 430	*14 430	*20 810	14 290	*13 420	7 610	*9 530	4 950	6 550	3 380			*4 440	3 140	
	Front outrigger and rear blade down (over rear)	*14 430	*14 430	*20 810	19 170	*13 420	9 740	*9 700	6 240	*7 360	4 300			*4 440	4 000	
	Front blade and rear outrigger down (over rear)	*14 430	*14 430	*20 810	19 640	*13 420	9 970	*9 700	6 370	7 170	4 400			*4 440	4 090	
	4 outrigger down (over rear)	*14 430	*14 430	*20 810	*20 810	*13 420	11 480	*9 700	7 350	*7 360	5 080			*4 440	*4 440	
-3.0 m	Rear blade up (over front)	*23 060	*23 060	17 910	9 960	9 000	5 530	5 650	3 510					4 550	2 810	6.9
	Rear blade down (over rear)	*23 060	*23 060	*22 080	11 500	*13 790	6 250	*9 570	3 970					*5 750	3 180	
	Rear outrigger down (over rear)	*23 060	*23 060	*22 080	14 140	*13 790	7 430	9 430	4 700					*5 750	3 780	
	Front outrigger and rear blade down (over rear)	*23 060	*23 060	*22 080	19 280	*13 790	9 550	*9 570	5 990					*5 750	4 820	
	Front blade and rear outrigger down (over rear)	*23 060	*23 060	*22 080	19 910	*13 790	9 780	*9 570	6 120					*5 750	4 920	
	4 outrigger down (over rear)	*23 060	*23 060	*22 080	*22 080	*13 790	11 510	*9 570	7 110					*5 750	5 710	
-4.5 m	Rear blade up (over front)	*31 570	*31 570	17 730	9 820									10 760	6 400	3.96
	Rear blade down (over rear)	*31 570	*31 570	*20 090	11 350									*13 630	7 290	
	Rear outrigger down (over rear)	*31 570	*31 570	*20 090	13 980									*13 630	8 770	
	Front outrigger and rear blade down (over rear)	*31 570	*31 570	*20 090	19 100									*13 630	11 470	
	Front blade and rear outrigger down (over rear)	*31 570	*31 570	*20 090	19 720									*13 630	11 770	
	4 outrigger down (over rear)	*31 570	*31 570	*20 090	*20 090									*13 630	*13 630	



**ZX220W-7 2-PIECE BOOM, ARM 2.91 M, 4 300 KG COUNTERWEIGHT, WIDE GAUGE**

Rating over-front or rear Rating over-side or 360 degrees Unit : kg

Load point height (m)	Stabilization	Load radius										At max. reach		meter			
		1.5 m		3.0 m		4.5 m		6.0 m		7.5 m							
7.5 m	Rear blade up (over front)																
	Rear blade down (over rear)																
	Rear outrigger down (over rear)																
	Front outrigger and rear blade down (over rear)																
	Front blade and rear outrigger down (over rear)																
	4 outrigger down (over rear)																
6.0 m	Rear blade up (over front)																
	Rear blade down (over rear)																
	Rear outrigger down (over rear)																
	Front outrigger and rear blade down (over rear)																
	Front blade and rear outrigger down (over rear)																
	4 outrigger down (over rear)																
4.5 m	Rear blade up (over front)																
	Rear blade down (over rear)																
	Rear outrigger down (over rear)																
	Front outrigger and rear blade down (over rear)																
	Front blade and rear outrigger down (over rear)																
	4 outrigger down (over rear)																
3.0 m	Rear blade up (over front)																
	Rear blade down (over rear)																
	Rear outrigger down (over rear)																
	Front outrigger and rear blade down (over rear)																
	Front blade and rear outrigger down (over rear)																
	4 outrigger down (over rear)																
1.5 m	Rear blade up (over front)																
	Rear blade down (over rear)																
	Rear outrigger down (over rear)																
	Front outrigger and rear blade down (over rear)																
	Front blade and rear outrigger down (over rear)																
	4 outrigger down (over rear)																
0 m (Ground)	Rear blade up (over front)																
	Rear blade down (over rear)																
	Rear outrigger down (over rear)																
	Front outrigger and rear blade down (over rear)																
	Front blade and rear outrigger down (over rear)																
	4 outrigger down (over rear)																
-1.5 m	Rear blade up (over front)																
	Rear blade down (over rear)																
	Rear outrigger down (over rear)																
	Front outrigger and rear blade down (over rear)																
	Front blade and rear outrigger down (over rear)																
	4 outrigger down (over rear)																
-3.0 m	Rear blade up (over front)																
	Rear blade down (over rear)																
	Rear outrigger down (over rear)																
	Front outrigger and rear blade down (over rear)																
	Front blade and rear outrigger down (over rear)																
	4 outrigger down (over rear)																
-4.5 m	Rear blade up (over front)																
	Rear blade down (over rear)																
	Rear outrigger down (over rear)																
	Front outrigger and rear blade down (over rear)																
	Front blade and rear outrigger down (over rear)																
	4 outrigger down (over rear)																

# MACHINE CAPACITIES

## ZX220W-7

- Notes:
1. Ratings are based on ISO 10567 : 2007.
  2. Machine capacity does not exceed 75% of tipping load with the machine on firm, level ground or 87% full hydraulic capacity.
  3. The load point is the center-line of the bucket pivot mounting pin on the arm.
  4. \*Indicates load limited by hydraulic capacity.
  5. Each value with Rear blade up over the Front-axle side and each value with Rear blade down over the Rear-axle side respectively, and value in optimal position with positioning cylinder.
  6. 0 m = Ground.

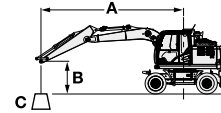

- A: Load radius  
B: Load point height  
C: Machine capacity

For machine capacities, subtract installed attachment and quick hitch weight from machine capacities.

To determine lifting capacities, apply "Rating over-side or 360 degrees" machine capacities from the table and deduct weight of installed attachment and quick hitch.



Optional feature may affect machine performance.













### ZX220W-7 2-PIECE BOOM, ARM 2.91 M, 5 000 KG COUNTERWEIGHT, STANDARD GAUGE

Rating over-front or rear Rating over-side or 360 degrees Unit : kg

Load point height (m)	Stabilization	Load radius										At max. reach		meter		
		1.5 m		3.0 m		4.5 m		6.0 m		7.5 m						
7.5 m	Rear blade up (over front)							*4 890	4 560					*3 880	*3 880	6.25
	Rear blade down (over rear)							*4 890	*4 890					*3 880	*3 880	
	Rear outrigger down (over rear)							*4 890	*4 890					*3 880	*3 880	
	Front outrigger and rear blade down (over rear)							*4 890	*4 890					*3 880	*3 880	
	Front blade and rear outrigger down (over rear)							*4 890	*4 890					*3 880	*3 880	
	4 outrigger down (over rear)							*4 890	*4 890					*3 880	*3 880	
6.0 m	Rear blade up (over front)							*6 110	4 670					*3 490	*3 200	7.4
	Rear blade down (over rear)							*6 110	5 160					*3 490	*3 490	
	Rear outrigger down (over rear)							*6 110	5 900					*3 490	*3 490	
	Front outrigger and rear blade down (over rear)							*6 110	*6 110					*3 490	*3 490	
	Front blade and rear outrigger down (over rear)							*6 110	*6 110					*3 490	*3 490	
	4 outrigger down (over rear)							*6 110	*6 110					*3 490	*3 490	
4.5 m	Rear blade up (over front)					*7 210	6 880	6 730	4 600	4 780	3 180			*3 450	2 710	8.1
	Rear blade down (over rear)					*7 210	*7 210	*6 880	5 100	*5 730	3 530			*3 350	3 030	
	Rear outrigger down (over rear)					*7 210	*7 210	*6 880	5 810	*5 730	4 080			*3 350	*3 350	
	Front outrigger and rear blade down (over rear)					*7 210	*7 210	*6 880	*6 880	*5 730	5 020			*3 350	*3 350	
	Front blade and rear outrigger down (over rear)					*7 210	*7 210	*6 880	*6 880	*5 730	5 120			*3 350	*3 350	
	4 outrigger down (over rear)					*7 210	*7 210	*6 880	*6 880	*5 730	*5 730			*3 350	*3 350	
3.0 m	Rear blade up (over front)			*11 610	*11 610	9 940	6 650	6 620	4 530	4 760	3 160			*3 360	2 460	8.47
	Rear blade down (over rear)			*11 610	*11 610	*10 150	*7 400	*7 850	5 020	*6 760	3 510			*3 360	2 760	
	Rear outrigger down (over rear)			*11 610	*11 610	*10 150	8 510	*7 850	5 730	*6 760	4 060			*3 360	3 230	
	Front outrigger and rear blade down (over rear)			*11 610	*11 610	*10 150	*10 150	*7 850	6 930	*6 760	5 000			*3 360	*3 360	
	Front blade and rear outrigger down (over rear)			*11 610	*11 610	*10 150	*10 150	*7 850	7 050	*6 760	5 100			*3 360	*3 360	
	4 outrigger down (over rear)			*11 610	*11 610	*10 150	*10 150	*7 850	*7 850	*6 760	5 790			*3 360	*3 360	
1.5 m	Rear blade up (over front)			*14 600	11 520	9 790	6 530	6 570	4 510	4 680	3 080			*3 520	2 370	8.55
	Rear blade down (over rear)			*14 600	*12 970	*12 230	7 270	*8 860	5 000	*7 200	3 430			*3 520	2 660	
	Rear outrigger down (over rear)			*14 600	*14 600	*12 230	8 370	*8 860	5 690	7 160	3 980			*3 520	3 120	
	Front outrigger and rear blade down (over rear)			*14 600	*14 600	*12 230	10 270	*8 860	6 870	*7 200	4 920			*3 520	*3 520	
	Front blade and rear outrigger down (over rear)			*14 600	*14 600	*12 230	10 480	*8 860	6 990	*7 200	5 010			*3 520	*3 520	
	4 outrigger down (over rear)			*14 600	*14 600	*12 230	*11 950	*8 860	*7 880	*7 200	5 710			*3 520	*3 520	
0 m (Ground)	Rear blade up (over front)	*8 850	*8 850	*17 310	11 470	9 820	6 490	6 640	4 370	4 550	2 940			*3 790	2 400	8.35
	Rear blade down (over rear)	*8 850	*8 850	*17 310	12 880	*13 250	7 260	*9 520	4 850	*7 510	3 290			*3 840	2 700	
	Rear outrigger down (over rear)	*8 850	*8 850	*17 310	15 450	*13 250	8 360	*9 520	5 630	7 140	3 850			*3 840	3 180	
	Front outrigger and rear blade down (over rear)	*8 850	*8 850	*17 310	*17 310	*13 250	10 310	*9 520	6 870	*7 510	4 790			*3 840	*3 840	
	Front blade and rear outrigger down (over rear)	*8 850	*8 850	*17 310	*17 310	*13 250	10 510	*9 520	7 010	*7 510	4 880			*3 840	*3 840	
	4 outrigger down (over rear)	*8 850	*8 850	*17 310	*17 310	*13 250	11 970	*9 520	*7 930	*7 510	5 580			*3 840	*3 840	
-1.5 m	Rear blade up (over front)	*14 430	*14 430	19 100	10 990	9 860	6 220	6 350	4 120	4 410	2 810			4 100	2 600	7.85
	Rear blade down (over rear)	*14 430	*14 430	*20 810	12 620	*13 420	6 980	*9 700	4 600	*7 360	3 150			*4 440	2 920	
	Rear outrigger down (over rear)	*14 430	*14 430	*20 810	15 410	*13 420	8 220	*9 700	5 370	*7 010	3 700			*4 440	3 440	
	Front outrigger and rear blade down (over rear)	*14 430	*14 430	*20 810	20 220	*13 420	10 430	*9 700	6 690	*7 360	4 650			*4 440	4 330	
	Front blade and rear outrigger down (over rear)	*14 430	*14 430	*20 810	20 690	*13 420	10 680	*9 700	6 830	*7 360	4 750			*4 440	4 420	
	4 outrigger down (over rear)	*14 430	*14 430	*20 810	*20 810	*13 420	12 190	*9 700	7 850	*7 360	5 450			*4 440	*4 440	
-3.0 m	Rear blade up (over front)	*23 060	*23 060	19 210	10 860	9 670	6 050	6 110	3 880					4 930	3 120	6.9
	Rear blade down (over rear)	*23 060	*23 060	*22 080	12 490	*13 790	6 800	*9 570	4 350					*5 750	3 510	
	Rear outrigger down (over rear)	*23 060	*23 060	*22 080	15 260	*13 790	8 030	*9 570	5 120					*5 750	4 130	
	Front outrigger and rear blade down (over rear)	*23 060	*23 060	*22 080	20 640	*13 790	10 240	*9 570	6 450					*5 750	5 200	
	Front blade and rear outrigger down (over rear)	*23 060	*23 060	*22 080	21 300	*13 790	10 480	*9 570	6 590					*5 750	5 310	
	4 outrigger down (over rear)	*23 060	*23 060	*22 080	*22 080	*13 790	12 270	*9 570	7 610					*5 750	*5 750	
-4.5 m	Rear blade up (over front)	*31 570	*31 570	19 030	10 730									11 580	7 020	3.96
	Rear blade down (over rear)	*31 570	*31 570	*20 090	12 340									*13 630	7 960	
	Rear outrigger down (over rear)	*31 570	*31 570	*20 090	15 100									*13 630	9 500	
	Front outrigger and rear blade down (over rear)	*31 570	*31 570	*20 090	*20 090									*13 630	12 310	
	Front blade and rear outrigger down (over rear)	*31 570	*31 570	*20 090	*20 090									*13 630	12 630	
	4 outrigger down (over rear)	*31 570	*31 570	*20 090	*20 090									*13 630	*13 630	

**ZX220W-7 2-PIECE BOOM, ARM 2.91 M, 5 000 KG COUNTERWEIGHT, WIDE GAUGE**

 Rating over-front or rear  Rating over-side or 360 degrees Unit : kg

Load point height (m)	Stabilization	Load radius										At max. reach		meter				
		1.5 m		3.0 m		4.5 m		6.0 m		7.5 m								
																		
7.5 m	Rear blade up (over front)																	
	Rear blade down (over rear)																	
	Rear outrigger down (over rear)																	
	Front outrigger and rear blade down (over rear)																	
	Front blade and rear outrigger down (over rear)																	
	4 outrigger down (over rear)																	
6.0 m	Rear blade up (over front)																	
	Rear blade down (over rear)																	
	Rear outrigger down (over rear)																	
	Front outrigger and rear blade down (over rear)																	
	Front blade and rear outrigger down (over rear)																	
	4 outrigger down (over rear)																	
4.5 m	Rear blade up (over front)																	
	Rear blade down (over rear)																	
	Rear outrigger down (over rear)																	
	Front outrigger and rear blade down (over rear)																	
	Front blade and rear outrigger down (over rear)																	
	4 outrigger down (over rear)																	
3.0 m	Rear blade up (over front)																	
	Rear blade down (over rear)																	
	Rear outrigger down (over rear)																	
	Front outrigger and rear blade down (over rear)																	
	Front blade and rear outrigger down (over rear)																	
	4 outrigger down (over rear)																	
1.5 m	Rear blade up (over front)																	
	Rear blade down (over rear)																	
	Rear outrigger down (over rear)																	
	Front outrigger and rear blade down (over rear)																	
	Front blade and rear outrigger down (over rear)																	
	4 outrigger down (over rear)																	
0 m (Ground)	Rear blade up (over front)																	
	Rear blade down (over rear)																	
	Rear outrigger down (over rear)																	
	Front outrigger and rear blade down (over rear)																	
	Front blade and rear outrigger down (over rear)																	
	4 outrigger down (over rear)																	
-1.5 m	Rear blade up (over front)																	
	Rear blade down (over rear)																	
	Rear outrigger down (over rear)																	
	Front outrigger and rear blade down (over rear)																	
	Front blade and rear outrigger down (over rear)																	
	4 outrigger down (over rear)																	
-3.0 m	Rear blade up (over front)																	
	Rear blade down (over rear)																	
	Rear outrigger down (over rear)																	
	Front outrigger and rear blade down (over rear)																	
	Front blade and rear outrigger down (over rear)																	
	4 outrigger down (over rear)																	
-4.5 m	Rear blade up (over front)																	
	Rear blade down (over rear)																	
	Rear outrigger down (over rear)																	
	Front outrigger and rear blade down (over rear)																	
	Front blade and rear outrigger down (over rear)																	
	4 outrigger down (over rear)																	



# EQUIPMENT

ENGINE	ZX220W-7
Aftertreatment device	●
Air cleaner double filters	●
Alternator 60 A	●
Auto idle system	●
Auto shut-down control	●
Cartridge-type engine oil filter	●
Cartridge-type fuel main filter	●
Cold fuel resistance valve	●
ConSite OIL (sensor)*	●
Coolant heater	○
DEF/AdBlue® tank	●
DEF/AdBlue® tank inlet strainer and extension filler	●
Dry-type air filter with evacuator valve (with air filter restriction indicator)	●
Dust-proof indoor net	●
ECO/PWR mode control	●
Electrical fuel feed pump	●
Engine oil drain coupler	●
Expansion tank	●
Fan guard	●
Fuel cooler	●
Fuel pre-filter with water separator	●
Isolation-mounted engine	●
Maintenance free pre-cleaner	○
Radiator, oil cooler and intercooler	●

HYDRAULIC SYSTEM	
Auto power lift	●
ConSite OIL (sensor)*	●
Control valve with main relief valve	●
Extra port for control valve	●
High mesh full-flow filter	●
Hose rupture valve for arm	●
Hose rupture valve for boom	●
Pilot filter	●
Power boost	●
Restriction indicator for full-flow filter	○
Shockless valve in pilot circuit	●
Steering filter	●
Suction filter	●
Swing dampener valve	●
Variable reliefvalve for breaker and crusher	●
Work mode selector	●

CAB	ZX220W-7
All-weather sound suppressed steel cab	●
Auto control air conditioner	●
AUX function lever (breaker assist)	●
Bluetooth®* integrated DAB+radio	●
Console height adjustment	●
Control lever auto-lock	●
CRES VII (center pillar reinforced structure) cab	●
Drink holder with hot and cool function	●
Electric double horn	●
Engine shut-off switch	●
Equipped with reinforced, tinted (green color) glass windows	●
Evacuation hammer	●
Floor mat	●
Footrest	●
Front window washer (2 points)	●
Glove compartment	●
Hands-free calling device	●
Hot and cool box	●
Intermittent windshield wipers	●
Key cylinder light	●
Laminated round glass window	○
LED room light	●
OPG top guard Level I (ISO10262 : 1998) compliant	●
OPG top guard Level II (ISO10262 : 1998) compliant	○
Pilot shut-off lever	●
Power outlet 12 V and 24 V	●
Push button low idle	●
Rain guard (without OPG front guard)	●
Rear tray	●
Retractable seat belt	●
ROPS (ISO12117-2 : 2008) compliant cab	●
Rubber radio antenna	●
Seat : air suspension seat with heater	●
Seat adjustment part : backrest, armrest, height and angle, slide forward / back	●
Seat belt reminder	●
Short wrist control levers	●
Smartphone holder	●
Sun visor (multi-use front or side window)	●
Sunscreen roller type (multi-use front or side and rear window)	○
Transparent roof with slide curtain	●
Wide view wiper	●
Windows on front, upper, lower and left side can be opened	●
2 speakers	●
4 fluid-filled elastic mounts	●
5V to USB power supply	●
8 inch monitor	●

Standard and optional equipment may vary by country, so please consult your Hitachi dealer for details.

\* Engine oil and hydraulic oil monitoring sensor.

\*\*The system detects the pilot pressure and maintains the set speed by maintaining the pilot pressure.

● : Standard equipment    ○ : Optional equipment

MONITOR SYSTEM	ZX220W-7
Alarm buzzers : overheat, engine oil pressure, overload, SCR system trouble, etc	●
Alarms : overheat, engine warning, engine oil pressure, alternator, minimum fuel level, hydraulic filter restriction, air filter restriction, work mode, overload, SCR system trouble, etc	●
Attachment operational information	●
Display of meters: Speedometer, Tachometer, Tripmeter, water temperature, hour, fuel rate, clock, DEF/AdBlue® rate, etc	●
Other displays: work mode, auto-idle, glow, rearview monitor, operating conditions, etc	●
35 languages selection	●

LIGHTS	
Additional boom LED light with cover	○
Additional cab roof front LED lights	○
Additional cab roof rear LED light	○
Brake lamps	●
Clearance lamps	○
Hazard lamps	●
Headlight LED	●
LED lights for camera (side and rear view camera)	○
Licence lamp	○
Rotating lamp (cab)	○
Rotating lamp (counterweight)	○
Turn signal lamps	●
Working LED lights	●
Working LED Lights under arm	○

UPPERSTRUCTURE	
AERIAL ANGLE® (270-degree view camera system)	●
Batteries 2 x 126 Ah	●
Battery disconnect switch	●
Body top guardrail	●
Cab top handhold	●
Counterweight 2 600kg	●
Counterweight 4 300kg	○
Counterweight 5 000kg	○
Electric fuel refilling pump with auto stop and filter	●
Fuel level float	●
Hydraulic oil level gauge	●
Lockable fuel refilling cap	●
Lockable machine covers	●
Platform handrail	●
Rear view mirror (right and left side)	●
Rear view mirrors with heater (right and left side)	○
Skid-resistant plates and handrails	●
Swing parking brake	●
Undercover	●

UNDERCARRIAGE	ZX220W-7
Automatic transmission control	●
Automatic working brake control	●
Clamshell bracket	○
Cruise control**	●
Electric system for trailer	○
Front cover	●
Front dozer blade + rear outrigger	○
Front fender / rear fender	○
Front outrigger + rear dozer blade	○
Front outrigger + rear outrigger	○
Parking brake	●
Rear dozer blade	○
Rear dozer blade, reinforced for trailer towing	○
Rear outrigger, prepared for trailer towing	○
Tool box: left side	●
Tool box: right side	○
Traction pattern tyres, single or twin type	●
Wide gauge axle	○
4 tie down brackets	●

FRONT ATTACHMENTS	
Arm tip remote lubrication	●
Auto-lubrication device (swing gear, boom, arm and bucket)	○
Casted bucket link A	●
Centralized lubrication system	●
Dirt seal on all bucket pins	●
Flanged pin	●
HN bushing	●
Lower arm reinforcement	○
Reinforced link B	○
Reinforced resin thrust plate	●
WC (tungsten-carbide) thermal spraying	●
Welded bucket link A	○
Welded bucket link A with welded hook	○

ATTACHMENT	
Accessories for 2 speed selector	○
Additional pump (40 L/min)	●
Assist piping	○
Breaker and crusher piping	●
Clamshell piping	○
Pilot accumulator	●
PTO valve	○

MISCELLANEOUS	
ConSite	○
Global e-Service	●
Onboard information controller	●
Standard tool kit	●
Travel direction mark on chassis frame	●







Prior to operating this machine, including satellite communication system, in a country other than a country of its intended use, it may be necessary to make modifications to it so that it complies with the local regulatory standards (including safety standards) and legal requirements of that particular country. Please do not export or operate this machine outside the country of its intended use until such compliance has been confirmed. Please contact your Hitachi dealer in case of questions about compliance.

These specifications are subject to change without notice. Illustrations and photos show the standard models, and may or may not include optional equipment, accessories, and all standard equipment with some differences in color and features. Before use, read and understand the Operator's Manual for proper operation.

